

Montana Tech Library

Digital Commons @ Montana Tech

Silver Bow Creek/Butte Area Superfund Site

Montana Superfund

Fall 11-4-2022

Draft Final 2022 Residential Metals Abatement Program (RMAP) Koprivica Park Soil Remedial Action Work Plan (RAWP)

Pioneer Technical Services, Inc.

Follow this and additional works at: https://digitalcommons.mtech.edu/superfund_silverbowbutte



Part of the [Environmental Health and Protection Commons](#), [Environmental Indicators and Impact Assessment Commons](#), and the [Environmental Monitoring Commons](#)

Atlantic Richfield Company

Mike Mc Anulty

Liability Manager

317 Anaconda Road

Butte MT 59701

Direct (406) 782-9964

Fax (406) 782-9980

November 4, 2022

Nikia Greene
Remedial Project Manager
US EPA – Montana Office
Baucus Federal Building
10 West 15th Street, Suite 3200
Helena, Montana 59626

Erin Agee
Senior Assistant Regional Counsel
US EPA Region 8 Office of Regional Counsel
CERCLA Enforcement Section
1595 Wynkoop Street
Denver, CO 80202
Mail Code: 8ORC-C

Daryl Reed
DEQ Project Officer
P.O. Box 200901
Helena, Montana 59620-0901

Jonathan Morgan, Esq.
DEQ, Legal Counsel
P.O. Box 200901
Helena, Montana 59620-0901

RE: Draft Final 2022 RMAP Koprivica Park Soil Remedial Action Work Plan (RAWP)

Agency Representatives:

I am writing to you on behalf of Atlantic Richfield Company and Butte-Silver Bow to submit the Draft Final 2022 RMAP Koprivica Park Soil Remedial Action Work Plan (RAWP). The report and appendices may be downloaded at the following link:

<https://pioneertechnicalservices.sharepoint.com/:f/s/submitted/EhbOBazFIhBkVKqFnS0TVEBS-ZFAhamEGaKm0kwiFjIEA>.

If you have any questions or comments, please call me at (907) 355-3914 or Eric Hassler at (406) 497-5042.

Sincerely,



Mike Mc Anulty
Liability Manager
Remediation Management Services Company
An affiliate of **Atlantic Richfield Company**



Eric Hassler, Director
Department of Reclamation
and Environmental Services
Butte-Silver Bow



Atlantic Richfield Company

Mike Mc Anulty

Liability Manager

317 Anaconda Road

Butte MT 59701

Direct (406) 782-9964

Fax (406) 782-9980

Cc: Patricia Gallery / Atlantic Richfield - email
Chris Greco / Atlantic Richfield – email
Josh Bryson / Atlantic Richfield – email
Mike McAnulty / Atlantic Richfield – email
Loren Burmeister / Atlantic Richfield – email
Dave Griffis / Atlantic Richfield - email
Jean Martin / Atlantic Richfield - email
Irene Montero / Atlantic Richfield - email
David A. Gratson / Environmental Standards / email
Mave Gasaway / DGS - email
Brienne McClafferty / Holland & Hart - email
Joe Vranka / EPA - email
David Shanight / CDM - email
Curt Coover / CDM - email
James Freeman / DOJ - email
John Sither / DOJ - email
Amy Steinmetz / DEQ - email
Dave Bowers / DEQ - email
Carolina Balliew / DEQ - email
Matthew Dorrington / DEQ – email
Wil George / DEQ – email
Jim Ford / NRDP - email
Pat Cunneen / NRDP - email
Harley Harris / NRDP - email
Katherine Hausrath / NRDP - email
Meranda Flugge / NRDP - email
Ted Duaine / MBMG - email
Gary Icopini / MBMG - email
Becky Summerville / MR - email
John DeJong / UP - email
Robert Bylsma / UP - email
John Gilmour / Kelley Drye - email
Leo Berry / BNSF - email
Robert Lowry / BNSF - email
Brooke Kuhl / BNSF – email
Lauren Knickrehm / BNSF - email
Jeremie Maehr / Kennedy Jenks - email
Doug Brannan / Kennedy Jenks - email
Matthew Mavrinac / RARUS - email
Harrison Roughton / RARUS - email
Brad Gordon / RARUS - email
Mark Neary / BSB - email
Eric Hassler / BSB - email

Atlantic Richfield Company

Mike Mc Anulty

Liability Manager

317 Anaconda Road

Butte MT 59701

Direct (406) 782-9964

Fax (406) 782-9980

Julia Crain / BSB - email
Chad Anderson / BSB - email
Brandon Warner / BSB – email
Abigail Peltomaa / BSB - email
Eileen Joyce / BSB – email
Sean Peterson/BSB – email
Gordon Hart / BSB – email
Dan Janosko / BSB – email
Karen Maloughney / BSB – email
Josh Vincent / WET - email
Craig Deeney / TREC - email
Scott Bradshaw / TREC - email
Brad Archibald / Pioneer - email
Pat Sampson / Pioneer - email
Joe McElroy / Pioneer – email
Andy Dare / Pioneer – email
Karen Helfrich / Pioneer – email
Leesla Jonart / Pioneer - email
Randa Colling / Pioneer – email
Ian Magruder/ CTEC- email
CTEC of Butte – email
Scott Juskiewicz / Montana Tech – email

File: MiningSharePoint@bp.com - email
BPSOU SharePoint - upload

**SILVER BOW CREEK/BUTTE AREA NPL SITE
BUTTE PRIORITY SOILS OPERABLE UNIT**

Draft Final

*2022 Residential Metals Abatement Program (RMAP)
Koprivica Park
Soil Remedial Action Work Plan (RAWP)*

Butte-Silver Bow County

and

Atlantic Richfield Company

November 4, 2022

**SILVER BOW CREEK/BUTTE AREA NPL SITE
BUTTE PRIORITY SOILS OPERABLE UNIT**

Draft Final

***2022 Residential Metals Abatement Program (RMAP)
Koprivica Park
Soil Remedial Action Work Plan (RAWP)***

Prepared for:

Butte-Silver Bow County
Superfund Division
155 W. Granite Street
Butte, Montana 59701

and

Atlantic Richfield Company
317 Anaconda Road
Butte, Montana 59701

Prepared by:

Pioneer Technical Services, Inc.
1101 S. Montana Street
Butte, Montana 59701

November 4, 2022

TABLE OF CONTENTS

	<u>Page</u>
1.0 INTRODUCTION	1
2.0 PARK SOIL REMEDIATION SCOPE.....	1
3.0 PARK SOIL REMEDIATION SCHEDULE	1
4.0 REMEDIAL ACTION WORK PLAN.....	1
4.1 Koprivica Park Remedial Action.....	1
4.2 Dust Control.....	3
4.3 Best Management Practices	3
5.0 MATERIALS.....	3
5.1 Sugar Beet Lime Source	3
5.2 Fabric Material.....	4
5.3 Type B Backfill Borrow Source	4
5.4 Backfill Borrow Source	4
5.5 Sand Cover Material	4
5.6 Sod	4
6.0 REFERENCES	5

LIST OF FIGURES

- Figure 1 P-0013 Koprivica Park Site Overview
- Figure 2 Removal Cross Sections
- Figure 3 Removal Details
- Figure 4 Mine Waste Repository Location
- Figure 5 Type B Borrow Stockpile Location
- Figure 6 Kaw Avenue Borrow Stockpile Location

LIST OF TABLES

- Table 1 Koprivica Park Property Information

LIST OF ATTACHMENTS

- Attachment A Draft Koprivica Park Individual Site Work Plan (ISWP)
- Attachment B Sugar Beet Lime QA Data
 - Attachment B-1 Energy Labs Data Reports
- Attachment C Fabric Specification Sheet
- Attachment D Type B Material Borrow Stockpile Data
 - Attachment D-1 Pace Analytical Data Reports
- Attachment E Agency Approved Kaw Avenue Borrow Stockpile Data
 - Attachment E-1 Energy Labs Data Report
 - Attachment E-2 Pace Analytical Data Report
- Attachment F S&N Concrete Aggregate Stockpile Data
 - Attachment F-1 Pace Analytical Data Reports

DOCUMENT MODIFICATION SUMMARY

Modification	Author	Version	Description	Date
0	Jesse Schwarzrock	Draft	Issued for Internal Review	10/24/22
1	Jesse Schwarzrock	Draft Final	Issued for Agency Review	11/04/22

1.0 INTRODUCTION

This Remedial Action Work Plan (RAWP) outlines a portion of the remedial action (RA) work resulting from the 2022 Residential Metals Abatement Program (RMAP) park soil sampling event that began in June 2022 and is currently on-going. The sampling event was conducted according to the *Final 2022 Residential Metals Abatement Program (RMAP) Quality Assurance Project Plan (QAPP) (Non-Residential Parcels)* (Butte-Silver Bow County and Atlantic Richfield Company, 2022a) and the *Final 2022 Residential Metals Abatement Program (RMAP) Park Soil Sampling Field Sampling Plan (FSP) Submittal #3 [Covering Koprivica Park, McGruff Park, Skate Park, Belmont Park, Rock Park, and Hanna Park]* (Butte-Silver Bow County and Atlantic Richfield Company, 2022b).

2.0 PARK SOIL REMEDIATION SCOPE

The scope of work covered by this RAWP includes the following park(s):

- Koprivica Park (see Table 1).

3.0 PARK SOIL REMEDIATION SCHEDULE

Remedial activities may begin in the Fall of 2022 but will most likely be initiated and completed during the 2023 construction season. All scheduling decisions will be vetted through relevant stakeholders to ensure minimal disturbance to the public.

4.0 REMEDIAL ACTION WORK PLAN

4.1 Koprivica Park Remedial Action

Remediation at Koprivica Park consists of two polygons totaling approximately 0.16 acres. Both Play Area 1 (PA1) and Play Area 2 (PA2) are in the extreme southwest corner of the park at the intersection of Oregon Avenue and East First Street.

- Polygon PA1 (3,494 square feet).
- Polygon PA2 (3,494 square feet).

Both polygons are playground areas with an existing sand material cover (approximately 6 inches thick) on top of the soil tested in this investigation (see Figure 1). The Individual Site Work Plan (ISWP) is provided in Attachment A.

4.1.1 Excavation

PA1 has a lead exceedance to a depth of 12 inches. PA2 did not have any exceedances; however, PA2 will be remediated along with PA1 since the two sampling areas constitute one continuous playground area that was split into two sampling areas due to QAPP (Butte-Silver Bow County and Atlantic Richfield Company, 2022a) sampling logic.

As previously discussed, both polygons have an existing 6-inch sand material cover. Based on this information, the removal area will be dictated by the original sampling polygon areas with the RMAP maximum remove depth of 14 inches below the existing sand material cover (see Detail 3 on Figure 2).

A 1-foot mandatory buffer will be maintained around all existing utilities. If achieving the removal depth means encroaching within the 1-foot mandatory utility buffer, excavation work will stop when at the 1-foot from utility mark. No removal work will take place within 1 foot of existing utilities. As mandated by Atlantic Richfield Company's *Remediation Management – Control of Work Defined Practices*, mechanical excavation is not allowed within 2 feet of existing utilities. Therefore, any excavation work within 2 feet of the utility will be hand excavation. The excavation depth will be measured from below the existing wood chip cover, where applicable.

Discussions with the park owner are on-going about existing playground equipment removal/replacement. At this time, it is anticipated that crews will remove and dispose of all existing playground equipment. Replacement equipment will be approved by the park owner prior to order and installation.

If the park owner chooses to keep any pieces of existing playground equipment, construction crews will conduct excavation work around these existing structures as site conditions allow. Crews will avoid disturbing soil adjacent to the playground equipment foundations and slope downward at a 45-degree angle until removal depth is achieved or another obstacle is encountered that limits further excavation. Crews will confer with the on-site U.S. Environmental Protection Agency (EPA) representative to make site-specific excavation decisions around any existing structures.

All excavated material will be disposed of within the Butte Mine Waste Repository (see Figure 4). Depth of the excavation area will be verified by measuring with a hand tape and using existing perimeter features (i.e., the elevation of the concrete curbing/tree areas/native soil around the excavation perimeter).

If excavations are not able to be backfilled during the same shift that they were developed, site control measures will be implemented during non-working hours. This may include perimeter control via safety cones and caution tape, construction fencing, or other approved methods.

4.1.2 Backfill

Once the on-site EPA representative approves the excavation area, backfill work will begin (see Detail 4 on Figure 2). A 2-inch-thick layer of sugar beet lime (see Section 5.1, Attachment B, and Attachment B-1) will be placed at the bottom of the excavation in case the underlying native soil has pH issues.

Once the lime layer is in place, a separation fabric (see Section 5.2 and Attachment C) will be placed, consistent with current RMAP practices. The separation fabric will indicate the boundary between remediated and native soil for any future excavation work in this area.

Once the separation fabric is installed, 12 inches of Type B fill material (see Section 5.3, Attachment D, and Attachment D-1) will be placed. The backfill material will not be compacted to attain a specific density and moisture content but will be slightly compacted to impede future settling of the backfill material.

After placement and compaction of Type B fill material is complete, a second layer of separation fabric will be placed to act as a weed barrier. Then a final 6-inch-thick layer of new sand cover material (or other owner approved cover material) will be placed on top of the weed barrier.

4.1.3 Revegetation

This playground area will be surfaced with sand material (or other owner-approved cover material). Therefore, revegetation is not anticipated for the primary work areas. However, existing sod may be disturbed through ingress/egress activities.

For those areas that need revegetation work, sod placement will be the most appropriate option given the maintained, irrigated nature of the property. Sod procurement is detailed in Section 5.6. All previously sodded areas disturbed during construction will receive sod. After final grading of backfill areas is complete, areas to be sodded will be raked or otherwise cleared of stones larger than 1 inch in any diameter, sticks, stumps, and other debris which might interfere with sodding, growth of grasses, or subsequent maintenance of grass-covered areas

4.2 Dust Control

This work will be performed within a residential area; consequently, controlling fugitive dust emissions is a high priority. If fugitive dust emissions become significant during the work, all work will be shut down until alternative and satisfactory dust control methods are determined. The contractor will be responsible for acquiring water for dust control from a source of the contractor's choice.

4.3 Best Management Practices

Best management practices (BMPs) will be installed as necessary to ensure sediment does not leave the work area.

5.0 MATERIALS

5.1 Sugar Beet Lime Source

Sugar beet lime will be procured from Western Sugar Cooperative in Billings, Montana. This material is currently being hauled from Billings to the Anaconda Smelter National Priorities List (NPL) Site. Internal quality assurance data from the past three months are provided in Attachment B. The corresponding laboratory reports are in Attachment B-1.

5.2 Fabric Material

Geotex 801 will be used for the separation fabric to provide a barrier between the growth medium and native soil. The material specifications are in Attachment C.

5.3 Type B Backfill Borrow Source

Type B fill material will be used for all required backfill material. Atlantic Richfield Company developed this fill material within the South Borrow Area of Remedial Design Unit (RDU) 8 of the Anaconda Smelter NPL Site in November 2020 (the location is shown on Figure 5) and screened it to a 6-inch minus product. The quality assurance data are provided in Attachment D, and the corresponding laboratory reports are in Attachment D-1. Because this material is fill material (not growth medium), only metals data are provided, consistent with past EPA requests in Anaconda.

5.4 Backfill Borrow Source

Growth medium is not anticipated to be necessary for the Koprivica Park RA at this time. In the event it is required, the Kaw Avenue growth medium borrow stockpile will be used (the location is shown on Figure 6). The Agency approved quality assurance data are provided in Attachment E, and the corresponding laboratory reports are in Attachments E-1 and E-2.

5.5 Sand Cover Material

Sand cover material will tentatively be procured from S&N Concrete in Anaconda, Montana. These discussions are still on-going with the park owner. The quality assurance data are provided in Attachment F, and the corresponding laboratory reports are in Attachment F-1. Because this material is cover material (not growth medium), only metals data are provided, consistent with past EPA requests in Anaconda.

5.6 Sod

If needed, Kentucky bluegrass sod will be procured from Summit Valley Turf in Whitehall, Montana.

6.0 REFERENCES

Butte-Silver Bow County and Atlantic Richfield Company, 2022a. Final 2022 Residential Metals Abatement Program (RMAP) Quality Assurance Project Plan (QAPP) (Non-Residential Parcels). Silver Bow Creek/Butte Area NPL Site Butte Priority Soils Operable Unit. June 21, 2022.

Butte-Silver Bow County and Atlantic Richfield Company, 2022b. Final 2022 Residential Metals Abatement Program (RMAP) Park Soil Sampling Field Sampling Plan (FSP) Submittal #3 [Covering Koprivica Park, McGruff Park, Skate Park, Belmont Park, Rock Park, and Hanna Park]. Silver Bow Creek/Butte Area NPL Site Butte Priority Soils Operable Unit. June 14, 2022.

FIGURES

NOTES:

1. PA1 AND PA2 WILL BE REMEDIATED PER DETAIL 3 ON FIGURE 2.

2. EVEN THOUGH PA2 CAME BACK BELOW ACTION LEVELS, IT WILL BE REMEDIATED ALONG WITH PA1. THESE TWO SAMPLING POLYGONS REPRESENT ONE PLAY AREA THAT WAS SPLIT INTO TWO SAMPLING AREAS DUE TO SAMPLING LOGIC IN THE QAPP.

3. WORK AROUND UTILITIES/UTILITY CORRIDORS WILL BE IN ACCORDANCE WITH BP'S CURRENT GROUND DISTURBANCE POLICY.



- LEGEND**
- No Action Required
 - 14" Removal
 - 26" Removal
 - Non-Samplable Area

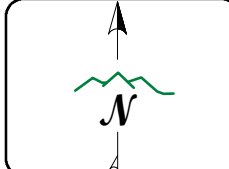

DISPLAYED AS:	MSP
PROJECTION/ZONE:	
DATUM:	NAD 83
UNITS:	FEET
SOURCE:	PIONEER

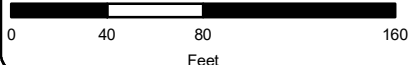

FIGURE 1

PIONEER
TECHNICAL SERVICES, INC.

P-0013

KOPRIVICA PARK

SITE OVERVIEW

DATE: 10/24/2022

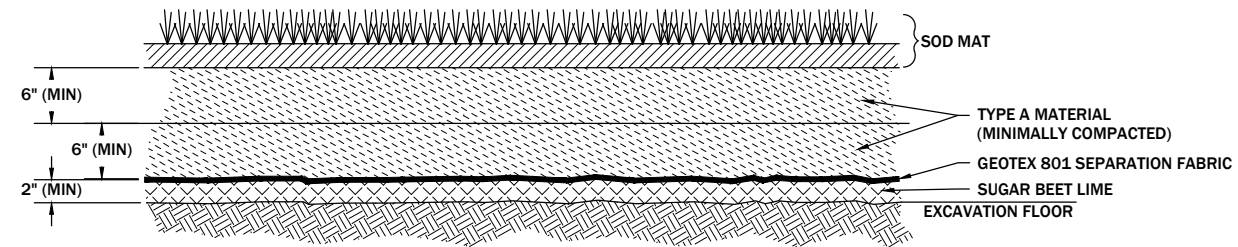

14" SOIL AND SOD REMOVAL/REPLACEMENT DETAIL

1
--

NOTE: 14" OF NATIVE SOIL TO BE REMOVED. IT WILL BE REPLACED WITH 2" OF LIME, A SEPARATION FABRIC, AND 12" OF TYPE A KAW AVENUE STOCKPILE GROWTH MEDIUM.

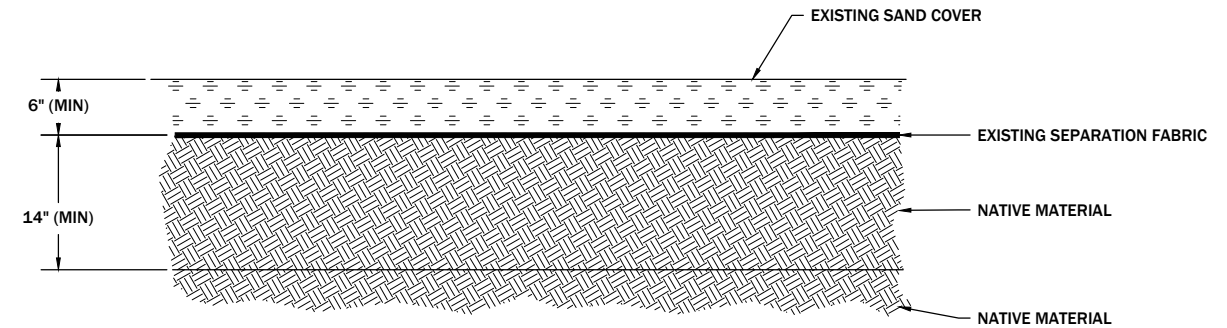

PA1 & PA2 REMOVAL DETAIL

3
--

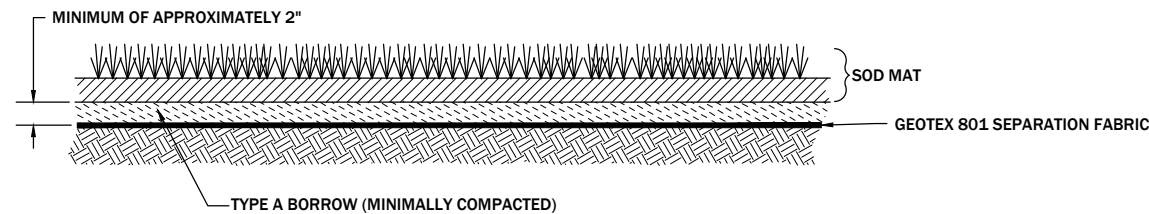

TREE CANOPY REMOVAL/REPLACEMENT DETAIL

2
--

NOTE: A FULL 14" OF REMOVAL WILL BE ATTEMPTED WITHIN TREE CANOPIES, BUT WILL NOT BE FEASIBLE IN ALL AREAS DUE TO TREE ROOTS. IN THESE AREAS, A MINIMUM REMOVAL OF THE EXISTING COVER MATERIAL (SOD/AGGREGATE) PLUS 2" OF NATIVE MATERIAL WILL BE ATTEMPTED. IN THIS SCENARIO, NO LIME WILL BE PLACED. A SEPARATION FABRIC, 2" OF KAW AVENUE STOCKPILE GROWTH MEDIUM, AND WOOD CHIPS/LANDSCAPING MATERIAL CHOSEN BY THE OWNER WILL BE PLACED TO BACKFILL THE EXCAVATION AREA.

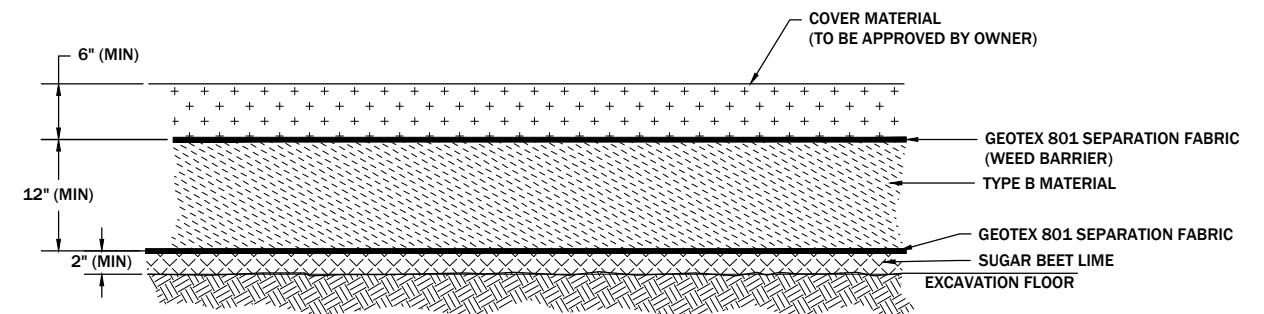

PA1 & PA2 REPLACEMENT DETAIL

4
--

DISPLAYED AS: _____
 COORD SYS/ZONE: _____
 DATUM: _____
 UNITS: _____
 SOURCE: _____

SCALE IN FEET
 0 NT5 NT5

FIGURE 2

REMOVAL CROSS SECTIONS

DATE: 10/24/2022

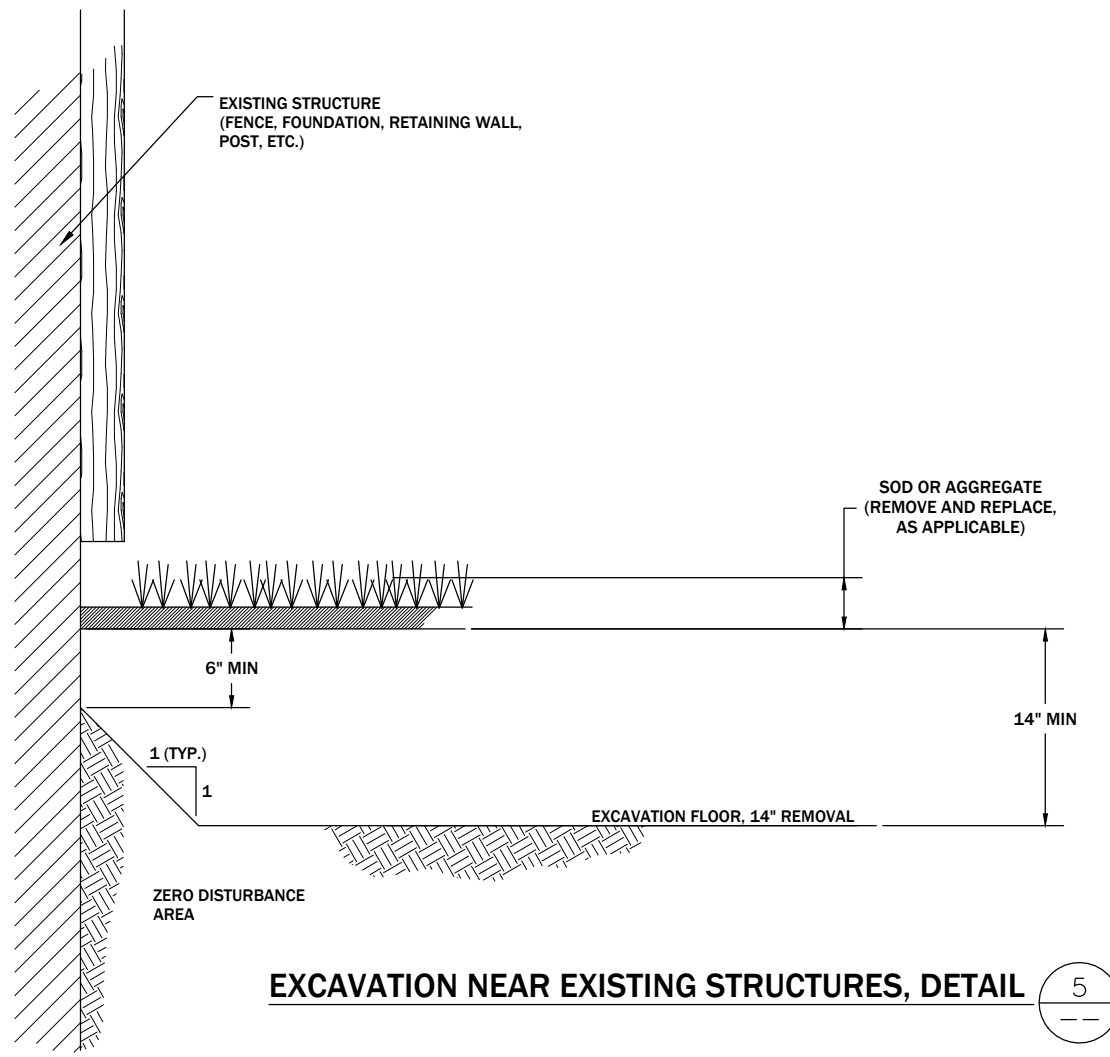

EXCAVATION NEAR EXISTING STRUCTURES, DETAIL (5)

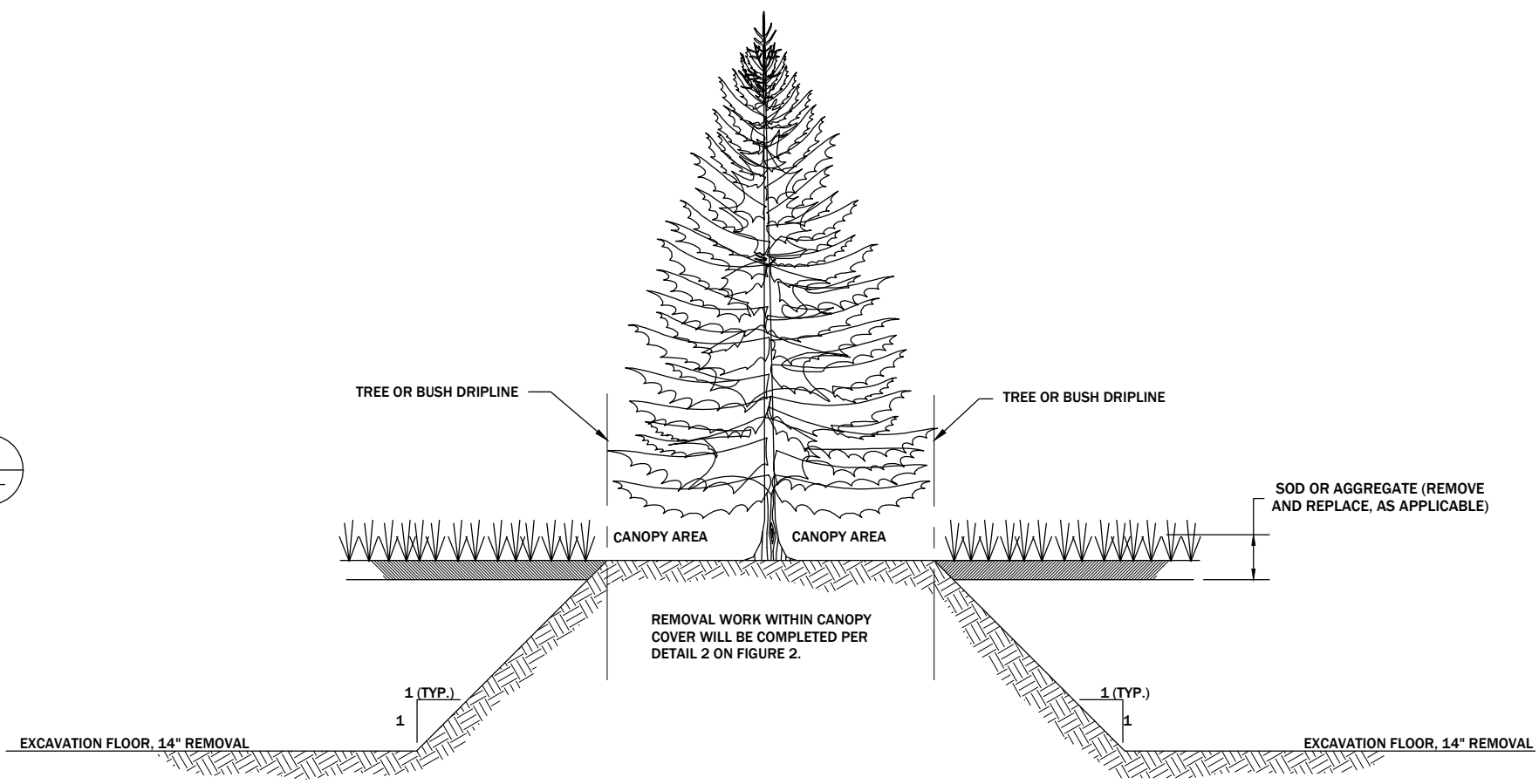

EXCAVATION NEAR EXISTING TREES, BUSHES, AND SHRUBS, DETAIL (6)

DISPLAYED AS: _____
 COORD SYS/ZONE: _____
 DATUM: _____
 UNITS: _____
 SOURCE: _____

SCALE IN FEET
 0 NT5 NT5

FIGURE 3

REMOVAL DETAILS

DATE: 10/24/2022

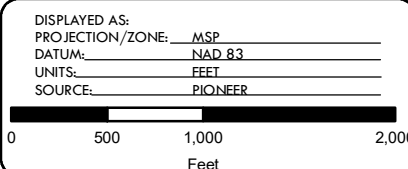
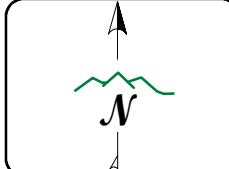

FIGURE 4
MINE WASTE REPOSITORY LOCATION
 DATE: 10/24/2022

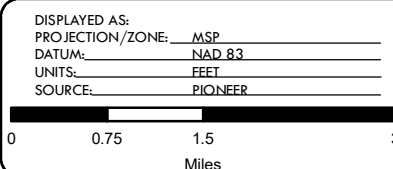
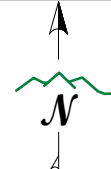
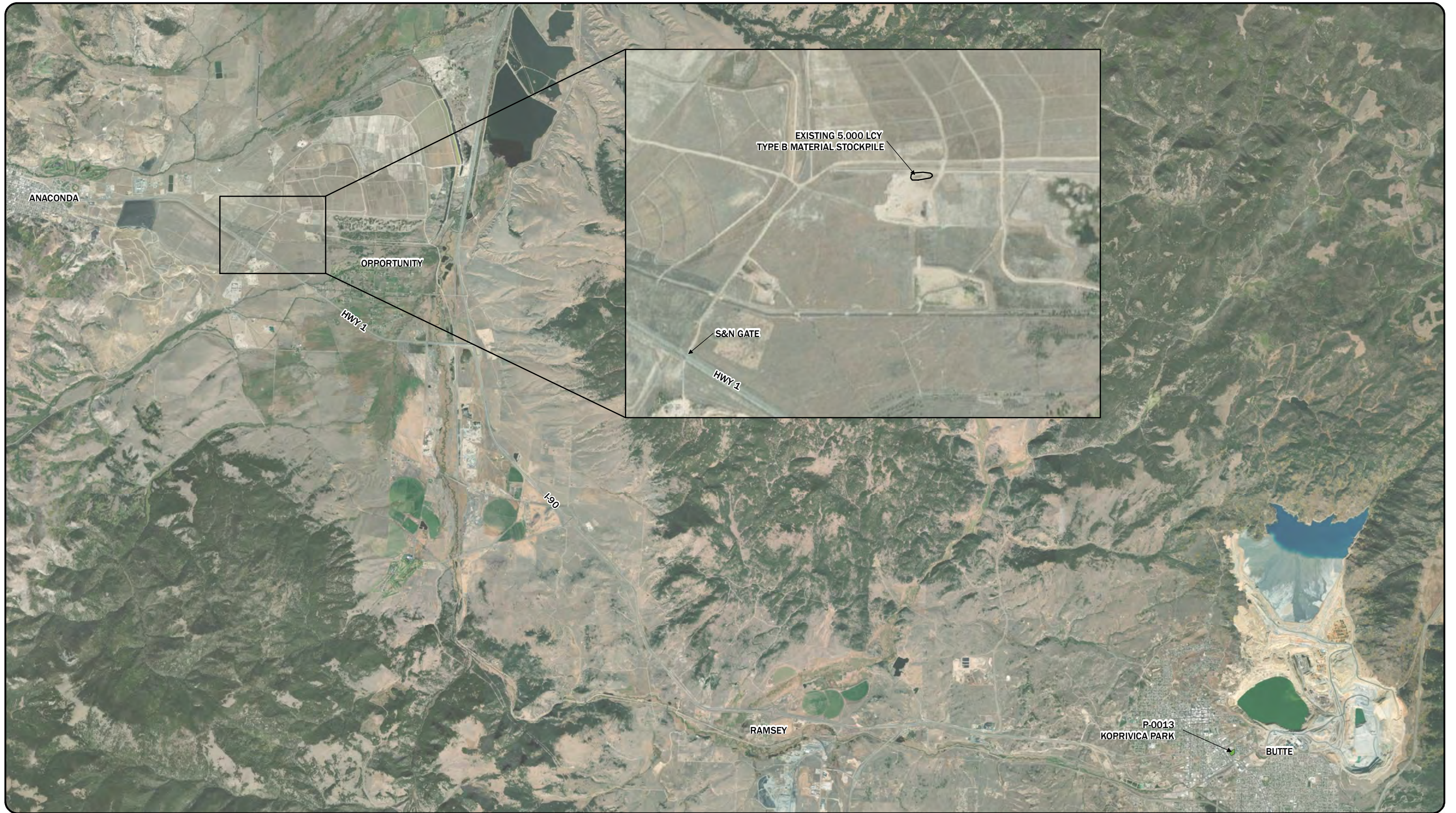

FIGURE 5

TYPE B BORROW STOCKPILE LOCATION

DATE: 10/24/2022



Path: Z:\Shared\Active Projects\ARCO\BPSOU\RMAP\GIS\Parks\Park RAWP Figures\KoprivicaPark\RAWP_KoprivicaPark6.mxd

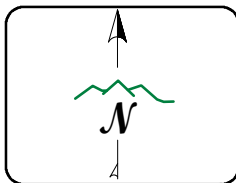

DISPLAYED AS: _____
 PROJECTION/ZONE: MSP _____
 DATUM: NAD 83 _____
 UNITS: FEET _____
 SOURCE: PIONEER _____

0 450 900 1,800
Feet

FIGURE 6

**KAW AVENUE
BORROW STOCKPILE
LOCATION**

DATE: 10/24/2022

TABLES

TABLE 1: KOPRIVICA PARK PROPERTY INFORMATION



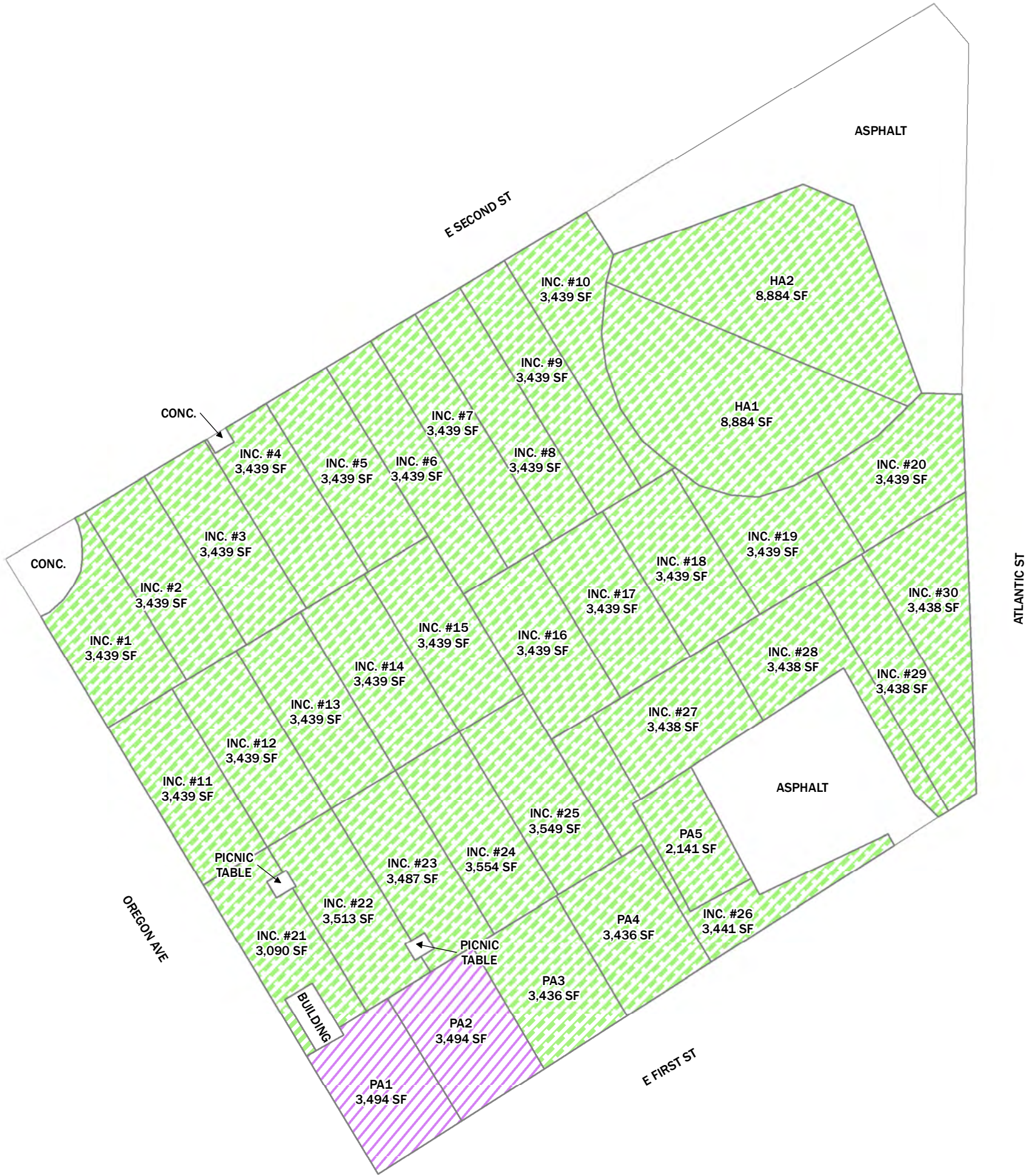

Count	Res-ID	Geocode	Name	Owner
1	P-0013	01119818301150000	Koprivica Park	Koprivica Family Park Inc

ATTACHMENT A
DRAFT KOPRIVICA PARK
INDIVIDUAL SITE WORK PLAN (ISWP)



P-0013

LEGEND

-  No Action Required
-  14" Removal
-  26" Removal
-  Un-Samplable Area

**KOPRIVICA PARK
 INDIVIDUAL SITE WORK PLAN**

RESIDENTIAL METALS
 ABATEMENT PROGRAM (RMAP)

BUTTE, MONTANA
 SHEET 1 OF 2

NOTES:

1. LOOK ON BACK OF SHEET FOR DATA TABLE.
2. EVEN THOUGH PA2 CAME BACK BELOW ACTION LEVELS, IT WILL BE REMEDIATED ALONG WITH PA1. THESE TWO SAMPLING POLYGONS REPRESENT ONE PLAY AREA THAT WAS SPLIT INTO TWO SAMPLING AREAS DUE TO SAMPLING LOGIC IN THE QAPP.

Boundaries on this site work plan DO NOT represent a legal survey. These boundaries are to be used for general reference only. No liability is assumed by Atlantic Richfield Company or Pioneer Technical Services for the accuracy of these.

DRAFT
 DATA VALIDATION
 NOT YET COMPLETE

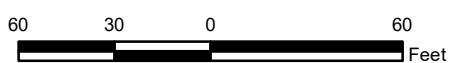
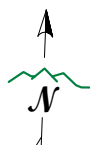

BY:



REMEDIAL ACTION SUMMARY TABLE

COMPOSITE SAMPLING DATA SUMMARY

Resident ID	SAMPLING COMPONENTS	COMPONENT SURFACE AREA (Square Feet)	COMPOSITE ARSENIC CONCENTRATION (mg/kg)				COMPOSITE LEAD CONCENTRATION (mg/kg)				COMPOSITE MERCURY CONCENTRATION (mg/kg)						
			0-2"	2-6"	6-12"	12-18"	18-24"	0-2"	2-6"	6-12"	12-18"	18-24"	0-2"	2-6"	6-12"	12-18"	18-24"
P-0013																	
P-0013-PA1	Playground Area 1 (PA1)	3,494	48	100	196	N/A	N/A	588	1,600	5,660	N/A	N/A	0.27	2.80	16.70	N/A	N/A
P-0013-PA2	Playground Area 2 (PA2)	3,494	76	138	133	N/A	N/A	703	1,060	1,150	N/A	N/A	0.44	0.59	1.10	N/A	N/A
P-0013-PA2-D-2	Play Area 2 (PA2) Duplicate	-	N/A	143	N/A	N/A	N/A	N/A	1,060	N/A	N/A	N/A	N/A	0.81	N/A	N/A	N/A
P-0013-PA3	Playground Area 3 (PA3)	3,436	87	120	126	N/A	N/A	840	849	798	N/A	N/A	0.44	0.63	0.43	N/A	N/A
P-0013-PA4	Playground Area 4 (PA4)	3,436	140	141	104	N/A	N/A	967	954	1,010	N/A	N/A	0.75	0.57	1.20	N/A	N/A
P-0013-PA5	Playground Area 5 (PA5)	2,141	18	17	24	N/A	N/A	71	67	112	N/A	N/A	0.03	0.02	0.02	N/A	N/A
P-0013-HA1	High Access Area 1 (HA1)	8,884	28	44	56	N/A	N/A	149	276	813	N/A	N/A	0.20	0.11	0.06	N/A	N/A
P-0013-HA1-D-2	High Access Area 1 (HA1) Duplicate	-	N/A	47	N/A	N/A	N/A	N/A	382	N/A	N/A	N/A	N/A	0.15	N/A	N/A	N/A
P-0013-HA2	High Access Area 2 (HA2)	8,884	23	51	73	N/A	N/A	167	393	820	N/A	N/A	0.10	0.10	0.19	N/A	N/A
		Max:	140	143	196	0	0	967	1,600	5,660	0	0	0.75	2.80	16.70	0.00	0.00

Composite Arsenic Concentration is \geq 250 mg/kg.
 Composite Lead Concentration is \geq 1,200 mg/kg.
 Composite Mercury Concentration is \geq 147 mg/kg.
 N/A = Not applicable per 2022 RMAP Quality Assurance Project Plan.

ISM SAMPLING DATA SUMMARY

Resident ID	SAMPLING COMPONENTS	COMPONENT SURFACE AREA (Square Feet)	ISM ARSENIC CONCENTRATION (mg/kg)		ISM LEAD CONCENTRATION (mg/kg)		ISM MERCURY CONCENTRATION (mg/kg)	
			0-2"	2-12"	0-2"	2-12"	0-2"	2-12"
P-0013								
P-0013-IS1	ISM Replicate A	103,158	45	80	442	747	0.29	0.57
P-0013-IS1	ISM Replicate B		38	82	478	823	0.37	0.49
P-0013-IS1	ISM Replicate C		29	79	338	636	0.45	0.53
	95% UCL:		51	83	542	894	0.50	0.60

ISM Arsenic 95% UCL is \geq 250 mg/kg.
 ISM Lead 95% UCL is \geq 1,200 mg/kg.
 ISM Mercury 95% UCL is \geq 147 mg/kg.
 N/A = Not applicable per 2022 RMAP Quality Assurance Project Plan.

REMEDIAL ACTION SUMMARY

Resident ID	SAMPLING COMPONENTS	COMPONENT SURFACE AREA (Square Feet)	ESTIMATED QUANTITIES			
			Excavation (Cubic Yards)	Lime (Cubic Yards)	General Backfill (Cubic Yards)	Cover Material (Square Feet)
P-0013						
P-0013-PA1	Playground Area 1 (PA1)	3,494	151	22	129	3,494
P-0013-PA2	Playground Area 2 (PA2)	3,494	151	22	129	3,494
P-0013-PA3	Playground Area 3 (PA3)	3,436	0	0	0	0
P-0013-PA4	Playground Area 4 (PA4)	3,436	0	0	0	0
P-0013-PA5	Playground Area 5 (PA5)	2,141	0	0	0	0
P-0013-HA1	High Access Area 1 (HA1)	8,884	0	0	0	0
P-0013-HA2	High Access Area 2 (HA2)	8,884	0	0	0	0
P-0013-IS1	ISM Polygon	103,158	0	0	0	0
		136,927	302	43	259	6,988

**KOPRIVICA PARK
INDIVIDUAL SITE WORK PLAN**

**RESIDENTIAL METALS
ABATEMENT PROGRAM (RMAP)**

**BUTTE, MONTANA
SHEET 2 OF 2**

DRAFT
DATA VALIDATION
NOT YET COMPLETE

Atlantic Richfield Company
A BP affiliated company

BY:



ATTACHMENT B
SUGAR BEET LIME QA DATA

**APPENDIX B - SUGAR BEET LIME QA DATA
(From ARWW&S, RDU 3)**

Sample ID	Date Collected	Butte Hill Reveg Spec:	Lime % as CaCO ₃	% Passing No. 60 Screen (dry)	
			Min of 65%	Min of 50%	
1	22RDU3_SBL_011	06/13/22	Volume Tested: Approximatley 4,500 cy	78.4%	93.9%
2	22RDU3_SBL_012	06/13/22		77.4%	94.3%
3	22RDU3_SBL_013	06/13/22		76.9%	92.8%
4	22RDU3_SBL_014	06/29/22		77.9%	95.7%
5	22RDU3_SBL_015	06/29/22		78.4%	95.9%
6	22RDU3_SBL_016	07/07/22		76.4%	99.3%
7	22RDU3_SBL_017	07/07/22		78.8%	98.5%
8	22RDU3_SBL_018	07/12/22		77.9%	97.0%
9	22RDU3_SBL_019	07/12/22		77.4%	96.3%
			MAX:	78.8%	99.3%
			MIN:	76.4%	92.8%
			AVE:	77.7%	96.0%

ATTACHMENT B-1
ENERGY LABS DATA REPORTS



ANALYTICAL SUMMARY REPORT

June 28, 2022

Woodard and Curran
1015 S Montana St
Butte, MT 59701-2805

Work Order: B22061398 Quote ID: B5361

Project Name: ARWW&S, RDU3, 0232257.03

Energy Laboratories Inc Billings MT received the following 3 samples for Woodard and Curran on 6/15/2022 for analysis.

Lab ID	Client Sample ID	Collect Date	Receive Date	Matrix	Test
B22061398-001	22RDU_3_SBL_011	06/13/22 14:45	06/15/22	Solid	Lime as CaCO3, % Moisture Sieve Analysis, Dry Sieve Analysis, Wet
B22061398-002	22RDU_3_SBL_012	06/13/22 14:50	06/15/22	Solid	Same As Above
B22061398-003	22RDU_3_SBL_013	06/13/22 14:55	06/15/22	Solid	Same As Above

The analyses presented in this report were performed by Energy Laboratories, Inc., 1120 S 27th St., Billings, MT 59101, unless otherwise noted. Any exceptions or problems with the analyses are noted in the report package. Any issues encountered during sample receipt are documented in the Work Order Receipt Checklist.

The results as reported relate only to the item(s) submitted for testing. This report shall be used or copied only in its entirety. Energy Laboratories, Inc. is not responsible for the consequences arising from the use of a partial report.

If you have any questions regarding these test results, please contact your Project Manager.

Report Approved By:



LABORATORY ANALYTICAL REPORT

Prepared by Billings, MT Branch

Client: Woodard and Curran
Project: ARWW&S, RDU3, 0232257.03

Report Date: 06/28/22

Lab ID: B22061398-001
Client Sample ID: 22RDU_3_SBL_011

Collection Date: 06/13/22 14:45
DateReceived: 06/15/22
Matrix: Solid

Analyses	Result	Units	Qualifiers	RL	MCL/ QCL	Method	Analysis Date / By
PHYSICAL CHARACTERISTICS							
Moisture (As Received)	28.6	wt%		0.2		D2974	06/21/22 10:09 / srm
CHEMICAL CHARACTERISTICS							
Lime as CaCO3	78.4	%		0.1		USDA23c	06/28/22 07:52 / srm
SIEVE ANALYSIS							
No. 60 (250um), Retained	84.4	wt%-wet		0.1		SSSA 15-2	06/28/22 07:42 / srm
No. 60 (250um), Passed	93.9	wt%-dry		0.1		SSSA 15-2	06/22/22 14:51 / srm
Pan	< 0.1	wt%-dry		0.1		SSSA 15-2	06/22/22 14:51 / srm
Pan	15.6	wt%-wet		0.1		SSSA 15-2	06/28/22 07:42 / srm

Lab ID: B22061398-002
Client Sample ID: 22RDU_3_SBL_012

Collection Date: 06/13/22 14:50
DateReceived: 06/15/22
Matrix: Solid

Analyses	Result	Units	Qualifiers	RL	MCL/ QCL	Method	Analysis Date / By
PHYSICAL CHARACTERISTICS							
Moisture (As Received)	28.8	wt%		0.2		D2974	06/21/22 10:09 / srm
CHEMICAL CHARACTERISTICS							
Lime as CaCO3	77.4	%		0.1		USDA23c	06/28/22 07:52 / srm
SIEVE ANALYSIS							
No. 60 (250um), Retained	90.9	wt%-wet		0.1		SSSA 15-2	06/28/22 07:42 / srm
No. 60 (250um), Passed	94.3	wt%-dry		0.1		SSSA 15-2	06/22/22 14:51 / srm
Pan	< 0.1	wt%-dry		0.1		SSSA 15-2	06/22/22 14:51 / srm
Pan	9.1	wt%-wet		0.1		SSSA 15-2	06/28/22 07:42 / srm

Report RL - Analyte Reporting Limit
Definitions: QCL - Quality Control Limit

MCL - Maximum Contaminant Level
ND - Not detected at the Reporting Limit (RL)



LABORATORY ANALYTICAL REPORT

Prepared by Billings, MT Branch

Client: Woodard and Curran
Project: ARWW&S, RDU3, 0232257.03

Report Date: 06/28/22

Lab ID: B22061398-003
Client Sample ID: 22RDU_3_SBL_013

Collection Date: 06/13/22 14:55
Date Received: 06/15/22
Matrix: Solid

Analyses	Result	Units	Qualifiers	RL	MCL/ QCL	Method	Analysis Date / By
PHYSICAL CHARACTERISTICS							
Moisture (As Received)	27.5	wt%		0.2		D2974	06/21/22 10:09 / srm
CHEMICAL CHARACTERISTICS							
Lime as CaCO3	76.9	%		0.1		USDA23c	06/28/22 07:52 / srm
SIEVE ANALYSIS							
No. 60 (250um), Retained	78.8	wt%-wet		0.1		SSSA 15-2	06/28/22 07:42 / srm
No. 60 (250um), Passed	92.8	wt%-dry		0.1		SSSA 15-2	06/22/22 14:51 / srm
Pan	< 0.1	wt%-dry		0.1		SSSA 15-2	06/22/22 14:51 / srm
Pan	21.2	wt%-wet		0.1		SSSA 15-2	06/28/22 07:42 / srm

Report RL - Analyte Reporting Limit
Definitions: QCL - Quality Control Limit

MCL - Maximum Contaminant Level
ND - Not detected at the Reporting Limit (RL)



QA/QC Summary Report

Prepared by Billings, MT Branch

Client: Woodard and Curran

Work Order: B22061398

Report Date: 06/28/22

Analyte	Result	Units	RL	%REC	Low Limit	High Limit	RPD	RPDLimit	Qual
Method: USDA23c							Batch: R383791		
Lab ID: B22061398-001A DUP	Sample Duplicate					Run: MISC-SOIL_220628A			06/28/22 07:52
Lime as CaCO3	78.4	%	0.10				0.0	30	
Lab ID: LCS-2206280752	Laboratory Control Sample					Run: MISC-SOIL_220628A			06/28/22 07:52
Lime as CaCO3	9.40	%	0.10	88	70	130			

Qualifiers:

RL - Analyte Reporting Limit

ND - Not detected at the Reporting Limit (RL)



Work Order Receipt Checklist

Woodard and Curran

B22061398

Login completed by: Yvonna E. Smith

Date Received: 6/15/2022

Reviewed by: BL2000\lcardreau

Received by: srg

Reviewed Date: 6/19/2022

Carrier name: Return-FedEx Ground

Shipping container/cooler in good condition?	Yes <input checked="" type="checkbox"/>	No <input type="checkbox"/>	Not Present <input type="checkbox"/>
Custody seals intact on all shipping container(s)/cooler(s)?	Yes <input checked="" type="checkbox"/>	No <input type="checkbox"/>	Not Present <input type="checkbox"/>
Custody seals intact on all sample bottles?	Yes <input type="checkbox"/>	No <input type="checkbox"/>	Not Present <input checked="" type="checkbox"/>
Chain of custody present?	Yes <input checked="" type="checkbox"/>	No <input type="checkbox"/>	
Chain of custody signed when relinquished and received?	Yes <input checked="" type="checkbox"/>	No <input type="checkbox"/>	
Chain of custody agrees with sample labels?	Yes <input checked="" type="checkbox"/>	No <input type="checkbox"/>	
Samples in proper container/bottle?	Yes <input checked="" type="checkbox"/>	No <input type="checkbox"/>	
Sample containers intact?	Yes <input checked="" type="checkbox"/>	No <input type="checkbox"/>	
Sufficient sample volume for indicated test?	Yes <input checked="" type="checkbox"/>	No <input type="checkbox"/>	
All samples received within holding time? (Exclude analyses that are considered field parameters such as pH, DO, Res Cl, Sulfite, Ferrous Iron, etc.)	Yes <input checked="" type="checkbox"/>	No <input type="checkbox"/>	
Temp Blank received in all shipping container(s)/cooler(s)?	Yes <input type="checkbox"/>	No <input checked="" type="checkbox"/>	Not Applicable <input type="checkbox"/>
Container/Temp Blank temperature:	14.3°C No Ice		
Containers requiring zero headspace have no headspace or bubble that is <6mm (1/4").	Yes <input type="checkbox"/>	No <input type="checkbox"/>	No VOA vials submitted <input checked="" type="checkbox"/>
Water - pH acceptable upon receipt?	Yes <input type="checkbox"/>	No <input type="checkbox"/>	Not Applicable <input checked="" type="checkbox"/>

Standard Reporting Procedures:

Lab measurement of analytes considered field parameters that require analysis within 15 minutes of sampling such as pH, Dissolved Oxygen and Residual Chlorine, are qualified as being analyzed outside of recommended holding time.

Solid/soil samples are reported on a wet weight basis (as received) unless specifically indicated. If moisture corrected, data units are typically noted as –dry. For agricultural and mining soil parameters/characteristics, all samples are dried and ground prior to sample analysis.

The reference date for Radon analysis is the sample collection date. The reference date for all other Radiochemical analyses is the analysis date. Radiochemical precision results represent a 2-sigma Total Measurement Uncertainty.

Contact and Corrective Action Comments:

None



ANALYTICAL SUMMARY REPORT

July 13, 2022

Woodard and Curran
1015 S Montana St
Butte, MT 59701-2805

Work Order: B22070163 Quote ID: B5361

Project Name: ARWW&S 0232257.04

Energy Laboratories Inc Billings MT received the following 2 samples for Woodard and Curran on 7/5/2022 for analysis.

Lab ID	Client Sample ID	Collect Date	Receive Date	Matrix	Test
B22070163-001	22RDU3_SBL_014	06/29/22 17:00	07/05/22	Solid	Lime as CaCO3, % Moisture Sieve Analysis, Dry Sieve Analysis, Wet
B22070163-002	22RDU3_SBL_015	06/29/22 17:10	07/05/22	Solid	Same As Above

The analyses presented in this report were performed by Energy Laboratories, Inc., 1120 S 27th St., Billings, MT 59101, unless otherwise noted. Any exceptions or problems with the analyses are noted in the report package. Any issues encountered during sample receipt are documented in the Work Order Receipt Checklist.

The results as reported relate only to the item(s) submitted for testing. This report shall be used or copied only in its entirety. Energy Laboratories, Inc. is not responsible for the consequences arising from the use of a partial report.

If you have any questions regarding these test results, please contact your Project Manager.

Report Approved By:



LABORATORY ANALYTICAL REPORT

Prepared by Billings, MT Branch

Client: Woodard and Curran
Project: ARWW&S 0232257.04

Report Date: 07/13/22

Lab ID: B22070163-001
Client Sample ID: 22RDU3_SBL_014

Collection Date: 06/29/22 17:00
DateReceived: 07/05/22
Matrix: Solid

Analyses	Result	Units	Qualifiers	RL	MCL/ QCL	Method	Analysis Date / By
PHYSICAL CHARACTERISTICS							
Moisture (As Received)	23.8	wt%		0.2		D2974	07/08/22 10:15 / srm
CHEMICAL CHARACTERISTICS							
Lime as CaCO3	77.9	%		0.1		USDA23c	07/13/22 15:11 / srm
SIEVE ANALYSIS							
No. 60 (250um), Retained	93.5	wt%-wet		0.1		SSSA 15-2	07/12/22 11:37 / srm
No. 60 (250um), Passed	95.7	wt%-dry		0.1		SSSA 15-2	07/08/22 11:26 / srm
Pan	< 0.1	wt%-dry		0.1		SSSA 15-2	07/08/22 11:26 / srm
Pan	6.5	wt%-wet		0.1		SSSA 15-2	07/12/22 11:37 / srm

Lab ID: B22070163-002
Client Sample ID: 22RDU3_SBL_015

Collection Date: 06/29/22 17:10
DateReceived: 07/05/22
Matrix: Solid

Analyses	Result	Units	Qualifiers	RL	MCL/ QCL	Method	Analysis Date / By
PHYSICAL CHARACTERISTICS							
Moisture (As Received)	22.3	wt%		0.2		D2974	07/08/22 10:15 / srm
CHEMICAL CHARACTERISTICS							
Lime as CaCO3	78.4	%		0.1		USDA23c	07/13/22 15:11 / srm
SIEVE ANALYSIS							
No. 60 (250um), Retained	88.1	wt%-wet		0.1		SSSA 15-2	07/12/22 11:37 / srm
No. 60 (250um), Passed	95.9	wt%-dry		0.1		SSSA 15-2	07/08/22 11:26 / srm
Pan	< 0.1	wt%-dry		0.1		SSSA 15-2	07/08/22 11:26 / srm
Pan	11.9	wt%-wet		0.1		SSSA 15-2	07/12/22 11:37 / srm

Report RL - Analyte Reporting Limit
Definitions: QCL - Quality Control Limit

MCL - Maximum Contaminant Level
ND - Not detected at the Reporting Limit (RL)



QA/QC Summary Report

Prepared by Billings, MT Branch

Client: Woodard and Curran

Work Order: B22070163

Report Date: 07/13/22

Analyte	Result	Units	RL	%REC	Low Limit	High Limit	RPD	RPDLimit	Qual
Method: USDA23c							Batch: R384614		
Lab ID: B22070163-001A DUP	Sample Duplicate					Run: MISC-SOIL_220713B			07/13/22 15:11
Lime as CaCO3	78.4	%	0.10				0.6	30	
Lab ID: LCS-2207131511	Laboratory Control Sample					Run: MISC-SOIL_220713B			07/13/22 15:11
Lime as CaCO3	9.80	%	0.10	92	70	130			

Qualifiers:

RL - Analyte Reporting Limit

ND - Not detected at the Reporting Limit (RL)



Work Order Receipt Checklist

Woodard and Curran

B22070163

Login completed by: Dylan A. Chirrick

Date Received: 7/5/2022

Reviewed by: gmccartney

Received by: dac

Reviewed Date: 7/9/2022

Carrier name: Return-FedEx Ground

Shipping container/cooler in good condition?	Yes <input checked="" type="checkbox"/>	No <input type="checkbox"/>	Not Present <input type="checkbox"/>
Custody seals intact on all shipping container(s)/cooler(s)?	Yes <input checked="" type="checkbox"/>	No <input type="checkbox"/>	Not Present <input type="checkbox"/>
Custody seals intact on all sample bottles?	Yes <input type="checkbox"/>	No <input type="checkbox"/>	Not Present <input checked="" type="checkbox"/>
Chain of custody present?	Yes <input checked="" type="checkbox"/>	No <input type="checkbox"/>	
Chain of custody signed when relinquished and received?	Yes <input checked="" type="checkbox"/>	No <input type="checkbox"/>	
Chain of custody agrees with sample labels?	Yes <input type="checkbox"/>	No <input checked="" type="checkbox"/>	
Samples in proper container/bottle?	Yes <input checked="" type="checkbox"/>	No <input type="checkbox"/>	
Sample containers intact?	Yes <input checked="" type="checkbox"/>	No <input type="checkbox"/>	
Sufficient sample volume for indicated test?	Yes <input checked="" type="checkbox"/>	No <input type="checkbox"/>	
All samples received within holding time? (Exclude analyses that are considered field parameters such as pH, DO, Res Cl, Sulfite, Ferrous Iron, etc.)	Yes <input checked="" type="checkbox"/>	No <input type="checkbox"/>	
Temp Blank received in all shipping container(s)/cooler(s)?	Yes <input type="checkbox"/>	No <input checked="" type="checkbox"/>	Not Applicable <input type="checkbox"/>
Container/Temp Blank temperature:	25.3°C No Ice		
Containers requiring zero headspace have no headspace or bubble that is <6mm (1/4").	Yes <input type="checkbox"/>	No <input type="checkbox"/>	No VOA vials submitted <input checked="" type="checkbox"/>
Water - pH acceptable upon receipt?	Yes <input type="checkbox"/>	No <input type="checkbox"/>	Not Applicable <input checked="" type="checkbox"/>

Standard Reporting Procedures:

Lab measurement of analytes considered field parameters that require analysis within 15 minutes of sampling such as pH, Dissolved Oxygen and Residual Chlorine, are qualified as being analyzed outside of recommended holding time.

Solid/soil samples are reported on a wet weight basis (as received) unless specifically indicated. If moisture corrected, data units are typically noted as –dry. For agricultural and mining soil parameters/characteristics, all samples are dried and ground prior to sample analysis.

The reference date for Radon analysis is the sample collection date. The reference date for all other Radiochemical analyses is the analysis date. Radiochemical precision results represent a 2-sigma Total Measurement Uncertainty.

Contact and Corrective Action Comments:

The sample identification indicated on the container label for sample 22RDU3_SBL_015 is 22RDU3_SBL_015 and on the Chain of Custody it is 22RDU3_SBL_15. Proceeded with the sample identification as indicated on the sample container.



Chain of Custody and Analytical Request Record

PLEASE PRINT (Provide as much information as possible.)

Company Name: **Woodard & Curran**
 Project Name, PWS, Permit, Etc.: **ARWW&S 0232257.04**
 EPA/State Compliance: Yes No
 Report Mail Address (Required): **1015 S Montana St Suite C, Butte MT, 59701**
 Contact Name: **Garrett Craig** Phone/Fax: **(406)291-2617**
 State: **MT**
 Sampler: (Please Print) **Shyla Wesely**
 Invoice Contact & Phone: **Kevin Bethke (406)586-8364**
 Purchase Order: **(406)291-2617**
 Quote/Bottle Order: _____

No Hard Copy Email: **gcraig@woodardcurran.com**
 Invoice Address (Required): **1800 Koch Suite A, Bozeman MT, 59715**
 No Hard Copy Email: **kbethke@woodardcurran.com**

Special Report/Formats:
 DW EDD/EDT (Electronic Data)
 POTW/WWTP **Format: _____**
 State: _____ LEVEL IV
 Other: _____ NELAC

SAMPLE IDENTIFICATION (Name, Location, Interval, etc.)	Collection Date	Collection Time	MATRIX	Number of Containers		Sample Type: A W S V B O DW Air Water Gols/Solids Vegetation Bioassay Other DW - Drinking Water	ANALYSIS REQUESTED	SEE ATTACHED	Standard Turnaround (TAT)	Comments:	Shipped by:
				Matrix	Other						
1 22RDU3_SBL_014	6/29/22	1700	S	✓		B361 - Lime Quality					
2 22RDU3_SBL_15	6/29/22	1710	S	✓							
3											
4											
5											
6											
7											
8											
9											
10											

Custody Record MUST be Signed

Relinquished by (print): **Shyla Wesely** Date/Time: **6/29/22** Signature: *[Signature]*
 Relinquished by (print): _____ Date/Time: _____ Signature: _____
 Received by (print): _____ Date/Time: _____ Signature: _____
 Received by (print): **Cydon Chiriac 15/22 11:15** Date/Time: _____ Signature: *[Signature]*
 Sample Disposal: _____ Return to Client: _____ Lab Disposal: _____
 Signature: _____ Date/Time: _____

In certain circumstances, samples submitted to Energy Laboratories, Inc. may be subcontracted to other certified laboratories in order to complete the analysis requested. This serves as notice of this possibility. All sub-contract data will be clearly notated on your analytical report. Visit our web site at www.energylab.com for additional information, downloadable fee schedule, forms, and links.



ANALYTICAL SUMMARY REPORT

July 20, 2022

Woodard and Curran
1015 S Montana St
Butte, MT 59701-2805

Work Order: B22070686 Quote ID: B5361

Project Name: ARWW&S, RDU3, 0232257.03

Energy Laboratories Inc Billings MT received the following 2 samples for Woodard and Curran on 7/11/2022 for analysis.

Lab ID	Client Sample ID	Collect Date	Receive Date	Matrix	Test
B22070686-001	22RDU3_SBL_016	07/07/22 11:20	07/11/22	Solid	Lime as CaCO3, % Moisture Sieve Analysis, Dry Sieve Analysis, Wet
B22070686-002	22RDU3_SBL_017	07/07/22 11:25	07/11/22	Solid	Same As Above

The analyses presented in this report were performed by Energy Laboratories, Inc., 1120 S 27th St., Billings, MT 59101, unless otherwise noted. Any exceptions or problems with the analyses are noted in the report package. Any issues encountered during sample receipt are documented in the Work Order Receipt Checklist.

The results as reported relate only to the item(s) submitted for testing. This report shall be used or copied only in its entirety. Energy Laboratories, Inc. is not responsible for the consequences arising from the use of a partial report.

If you have any questions regarding these test results, please contact your Project Manager.

Report Approved By:



LABORATORY ANALYTICAL REPORT

Prepared by Billings, MT Branch

Client: Woodard and Curran
Project: ARWW&S, RDU3, 0232257.03

Report Date: 07/20/22

Lab ID: B22070686-001
Client Sample ID: 22RDU3_SBL_016

Collection Date: 07/07/22 11:20
DateReceived: 07/11/22
Matrix: Solid

Analyses	Result	Units	Qualifiers	RL	MCL/ QCL	Method	Analysis Date / By
PHYSICAL CHARACTERISTICS							
Moisture (As Received)	25.7	wt%		0.2		D2974	07/19/22 09:43 / srm
CHEMICAL CHARACTERISTICS							
Lime as CaCO3	76.4	%		0.1		USDA23c	07/20/22 15:36 / srm
SIEVE ANALYSIS							
No. 60 (250um), Retained	76.9	wt%-wet		0.1		SSSA 15-2	07/20/22 11:27 / srm
No. 60 (250um), Passed	99.3	wt%-dry		0.1		SSSA 15-2	07/19/22 10:34 / srm
Pan	< 0.1	wt%-dry		0.1		SSSA 15-2	07/19/22 10:34 / srm
Pan	23.1	wt%-wet		0.1		SSSA 15-2	07/20/22 11:27 / srm

Lab ID: B22070686-002
Client Sample ID: 22RDU3_SBL_017

Collection Date: 07/07/22 11:25
DateReceived: 07/11/22
Matrix: Solid

Analyses	Result	Units	Qualifiers	RL	MCL/ QCL	Method	Analysis Date / By
PHYSICAL CHARACTERISTICS							
Moisture (As Received)	25.9	wt%		0.2		D2974	07/19/22 09:43 / srm
CHEMICAL CHARACTERISTICS							
Lime as CaCO3	78.8	%		0.1		USDA23c	07/20/22 15:36 / srm
SIEVE ANALYSIS							
No. 60 (250um), Retained	26.8	wt%-wet		0.1		SSSA 15-2	07/20/22 11:27 / srm
No. 60 (250um), Passed	98.5	wt%-dry		0.1		SSSA 15-2	07/19/22 10:34 / srm
Pan	< 0.1	wt%-dry		0.1		SSSA 15-2	07/19/22 10:34 / srm
Pan	73.2	wt%-wet		0.1		SSSA 15-2	07/20/22 11:27 / srm

Report RL - Analyte Reporting Limit
Definitions: QCL - Quality Control Limit

MCL - Maximum Contaminant Level
ND - Not detected at the Reporting Limit (RL)



QA/QC Summary Report

Prepared by Billings, MT Branch

Client: Woodard and Curran

Work Order: B22070686

Report Date: 07/20/22

Analyte	Result	Units	RL	%REC	Low Limit	High Limit	RPD	RPDLimit	Qual
Method: USDA23c							Batch: R384936		
Lab ID: B22070686-001A DUP	Sample Duplicate					Run: MISC-SOIL_220720B			07/20/22 15:36
Lime as CaCO3	75.9	%	0.10				0.7	30	
Lab ID: LCS-2207201536	Laboratory Control Sample					Run: MISC-SOIL_220720B			07/20/22 15:36
Lime as CaCO3	9.50	%	0.10	89	70	130			

Qualifiers:

RL - Analyte Reporting Limit

ND - Not detected at the Reporting Limit (RL)



Work Order Receipt Checklist

Woodard and Curran

B22070686

Login completed by: Dylan A. Chirrick

Date Received: 7/11/2022

Reviewed by: BL2000\lcardreau

Received by: dac

Reviewed Date: 7/12/2022

Carrier name: Return-FedEx Ground

Shipping container/cooler in good condition?	Yes <input checked="" type="checkbox"/>	No <input type="checkbox"/>	Not Present <input type="checkbox"/>
Custody seals intact on all shipping container(s)/cooler(s)?	Yes <input checked="" type="checkbox"/>	No <input type="checkbox"/>	Not Present <input type="checkbox"/>
Custody seals intact on all sample bottles?	Yes <input type="checkbox"/>	No <input type="checkbox"/>	Not Present <input checked="" type="checkbox"/>
Chain of custody present?	Yes <input checked="" type="checkbox"/>	No <input type="checkbox"/>	
Chain of custody signed when relinquished and received?	Yes <input checked="" type="checkbox"/>	No <input type="checkbox"/>	
Chain of custody agrees with sample labels?	Yes <input checked="" type="checkbox"/>	No <input type="checkbox"/>	
Samples in proper container/bottle?	Yes <input checked="" type="checkbox"/>	No <input type="checkbox"/>	
Sample containers intact?	Yes <input checked="" type="checkbox"/>	No <input type="checkbox"/>	
Sufficient sample volume for indicated test?	Yes <input checked="" type="checkbox"/>	No <input type="checkbox"/>	
All samples received within holding time? (Exclude analyses that are considered field parameters such as pH, DO, Res Cl, Sulfite, Ferrous Iron, etc.)	Yes <input checked="" type="checkbox"/>	No <input type="checkbox"/>	
Temp Blank received in all shipping container(s)/cooler(s)?	Yes <input checked="" type="checkbox"/>	No <input type="checkbox"/>	Not Applicable <input type="checkbox"/>
Container/Temp Blank temperature:	24.0°C No Ice		
Containers requiring zero headspace have no headspace or bubble that is <6mm (1/4").	Yes <input type="checkbox"/>	No <input type="checkbox"/>	No VOA vials submitted <input checked="" type="checkbox"/>
Water - pH acceptable upon receipt?	Yes <input type="checkbox"/>	No <input type="checkbox"/>	Not Applicable <input checked="" type="checkbox"/>

Standard Reporting Procedures:

Lab measurement of analytes considered field parameters that require analysis within 15 minutes of sampling such as pH, Dissolved Oxygen and Residual Chlorine, are qualified as being analyzed outside of recommended holding time.

Solid/soil samples are reported on a wet weight basis (as received) unless specifically indicated. If moisture corrected, data units are typically noted as –dry. For agricultural and mining soil parameters/characteristics, all samples are dried and ground prior to sample analysis.

The reference date for Radon analysis is the sample collection date. The reference date for all other Radiochemical analyses is the analysis date. Radiochemical precision results represent a 2-sigma Total Measurement Uncertainty.

Contact and Corrective Action Comments:

None



Chain of Custody and Analytical Request Record

PLEASE PRINT (Provide as much information as possible.)

Company Name: Woodard & Curran		Project Name, PWS, Permit, Etc. ARWW&S, RDU3, 0232257.03		Sample Origin State: MT		EPA/State Compliance: Yes <input type="checkbox"/> No <input type="checkbox"/>	
Report Mail Address (Required): 1015 S Montana St Suite C, Butte MT, 59701		Contact Name: Garrett Craig		Phone/Fax: (406)291-2617		Cell: (406)291-2617	
<input checked="" type="checkbox"/> No Hard Copy Email: gcraig@woodardcurran.com		Invoice Contact & Phone: Kevin Bethke (406)586-8364		Purchase Order:		Quote/Bottle Order:	
Invoice Address (Required): 1800 Koch Suite A, Bozeman MT, 59715		Standard Turnaround (TAT)		Comments: Contact ELI prior to RUSH sample submittal for charges and scheduling - See Instruction Page		Shipped by:	
<input type="checkbox"/> No Hard Copy Email: kbethke@woodardcurran.com		ANALYSIS REQUESTED		SEE ATTACHED		Cooler ID(s):	
Special Report/Formats: <input type="checkbox"/> DW <input type="checkbox"/> EDD/EDT (Electronic Data) <input type="checkbox"/> POTW/WWTP <input type="checkbox"/> Format: <input type="checkbox"/> State: <input type="checkbox"/> LEVEL IV <input type="checkbox"/> Other: <input type="checkbox"/> NELAC		Number of Containers Sample Type: A W S V B O DW Air Water Soils/Solids Vegetation Bioassay Other DW - Drinking Water B5361 - Time Quality		R U S H		Receipt Temp °C On Ice: Y N	
SAMPLE IDENTIFICATION (Name, Location, Interval, etc.)		Collection Date		Collection Time		Custody Seal On Bottle Y N On Cooler Y N	
1 22RDU3_SBL_016		07/07/2022		11:20		Intact Y N	
2 22RDU3_SBL_017		07/07/2022		11:25		Signature Match Y N	
3						Signature _____	
4						Signature _____	
5						Signature _____	
6						Signature _____	
7						Signature _____	
8						Signature _____	
9						Signature _____	
10						Signature _____	

Custody Record MUST be Signed

Relinquished by (print): Hannah Foster 7/9/22
Signature: _____ Date/Time: 07/08/22 12:00

Relinquished by (print): _____
Signature: _____ Date/Time: 12:00pm

Received by (print): _____
Signature: _____ Date/Time: _____

Received by (print): _____
Signature: _____ Date/Time: _____

Received by Laboratory: _____
Signature: _____ Date/Time: _____

Sample Disposal: _____ Return to Client: Lab Disposal:

In certain circumstances, samples submitted to Energy Laboratories, Inc. may be subcontracted to other certified laboratories in order to complete the analysis requested. This serves as notice of this possibility. All sub-contract data will be clearly notated on your analytical report. Visit our web site at www.energylab.com for additional information, downloadable fee schedule, forms, and links.



ANALYTICAL SUMMARY REPORT

July 20, 2022

Woodard and Curran
1015 S Montana St
Butte, MT 59701-2805

Work Order: B22071162 Quote ID: B5361

Project Name: ARWW&S, RDU3, 0232257.03

Energy Laboratories Inc Billings MT received the following 2 samples for Woodard and Curran on 7/14/2022 for analysis.

Lab ID	Client Sample ID	Collect Date	Receive Date	Matrix	Test
B22071162-001	22RDU3_SBL_018	07/12/22 15:00	07/14/22	Solid	Lime as CaCO3, % Moisture Sieve Analysis, Dry Sieve Analysis, Wet
B22071162-002	22RDU3_SBL_019	07/12/22 15:05	07/14/22	Solid	Same As Above

The analyses presented in this report were performed by Energy Laboratories, Inc., 1120 S 27th St., Billings, MT 59101, unless otherwise noted. Any exceptions or problems with the analyses are noted in the report package. Any issues encountered during sample receipt are documented in the Work Order Receipt Checklist.

The results as reported relate only to the item(s) submitted for testing. This report shall be used or copied only in its entirety. Energy Laboratories, Inc. is not responsible for the consequences arising from the use of a partial report.

If you have any questions regarding these test results, please contact your Project Manager.

Report Approved By:



LABORATORY ANALYTICAL REPORT

Prepared by Billings, MT Branch

Client: Woodard and Curran
Project: ARWW&S, RDU3, 0232257.03

Report Date: 07/20/22

Lab ID: B22071162-001
Client Sample ID: 22RDU3_SBL_018

Collection Date: 07/12/22 15:00
DateReceived: 07/14/22
Matrix: Solid

Analyses	Result	Units	Qualifiers	RL	MCL/ QCL	Method	Analysis Date / By
PHYSICAL CHARACTERISTICS							
Moisture (As Received)	23.4	wt%		0.2		D2974	07/19/22 09:43 / srm
CHEMICAL CHARACTERISTICS							
Lime as CaCO3	77.9	%		0.1		USDA23c	07/20/22 15:36 / srm
SIEVE ANALYSIS							
No. 60 (250um), Retained	60.8	wt%-wet		0.1		SSSA 15-2	07/20/22 11:27 / srm
No. 60 (250um), Passed	97.0	wt%-dry		0.1		SSSA 15-2	07/19/22 10:36 / srm
Pan	< 0.1	wt%-dry		0.1		SSSA 15-2	07/19/22 10:36 / srm
Pan	39.2	wt%-wet		0.1		SSSA 15-2	07/20/22 11:27 / srm

Lab ID: B22071162-002
Client Sample ID: 22RDU3_SBL_019

Collection Date: 07/12/22 15:05
DateReceived: 07/14/22
Matrix: Solid

Analyses	Result	Units	Qualifiers	RL	MCL/ QCL	Method	Analysis Date / By
PHYSICAL CHARACTERISTICS							
Moisture (As Received)	31.7	wt%		0.2		D2974	07/19/22 09:43 / srm
CHEMICAL CHARACTERISTICS							
Lime as CaCO3	77.4	%		0.1		USDA23c	07/20/22 15:36 / srm
SIEVE ANALYSIS							
No. 60 (250um), Retained	79.7	wt%-wet		0.1		SSSA 15-2	07/20/22 11:27 / srm
No. 60 (250um), Passed	96.3	wt%-dry		0.1		SSSA 15-2	07/19/22 10:36 / srm
Pan	< 0.1	wt%-dry		0.1		SSSA 15-2	07/19/22 10:36 / srm
Pan	20.3	wt%-wet		0.1		SSSA 15-2	07/20/22 11:27 / srm

Report RL - Analyte Reporting Limit
Definitions: QCL - Quality Control Limit

MCL - Maximum Contaminant Level
ND - Not detected at the Reporting Limit (RL)



QA/QC Summary Report

Prepared by Billings, MT Branch

Client: Woodard and Curran

Work Order: B22071162

Report Date: 07/20/22

Analyte	Result	Units	RL	%REC	Low Limit	High Limit	RPD	RPDLimit	Qual
Method: USDA23c							Batch: R384936		
Lab ID: B22070686-001A DUP	Sample Duplicate					Run: MISC-SOIL_220720B			07/20/22 15:36
Lime as CaCO3	75.9	%	0.10				0.7	30	
Lab ID: LCS-2207201536	Laboratory Control Sample					Run: MISC-SOIL_220720B			07/20/22 15:36
Lime as CaCO3	9.50	%	0.10	89	70	130			

Qualifiers:

RL - Analyte Reporting Limit

ND - Not detected at the Reporting Limit (RL)



Work Order Receipt Checklist

Woodard and Curran

B22071162

Login completed by: Tyler J. Gasser

Date Received: 7/14/2022

Reviewed by: gmccartney

Received by: tae

Reviewed Date: 7/19/2022

Carrier name: Return-FedEx Ground

Shipping container/cooler in good condition?	Yes <input checked="" type="checkbox"/>	No <input type="checkbox"/>	Not Present <input type="checkbox"/>
Custody seals intact on all shipping container(s)/cooler(s)?	Yes <input checked="" type="checkbox"/>	No <input type="checkbox"/>	Not Present <input type="checkbox"/>
Custody seals intact on all sample bottles?	Yes <input type="checkbox"/>	No <input type="checkbox"/>	Not Present <input checked="" type="checkbox"/>
Chain of custody present?	Yes <input checked="" type="checkbox"/>	No <input type="checkbox"/>	
Chain of custody signed when relinquished and received?	Yes <input checked="" type="checkbox"/>	No <input type="checkbox"/>	
Chain of custody agrees with sample labels?	Yes <input checked="" type="checkbox"/>	No <input type="checkbox"/>	
Samples in proper container/bottle?	Yes <input checked="" type="checkbox"/>	No <input type="checkbox"/>	
Sample containers intact?	Yes <input checked="" type="checkbox"/>	No <input type="checkbox"/>	
Sufficient sample volume for indicated test?	Yes <input checked="" type="checkbox"/>	No <input type="checkbox"/>	
All samples received within holding time? (Exclude analyses that are considered field parameters such as pH, DO, Res Cl, Sulfite, Ferrous Iron, etc.)	Yes <input checked="" type="checkbox"/>	No <input type="checkbox"/>	
Temp Blank received in all shipping container(s)/cooler(s)?	Yes <input checked="" type="checkbox"/>	No <input type="checkbox"/>	Not Applicable <input type="checkbox"/>
Container/Temp Blank temperature:	22.4°C No Ice		
Containers requiring zero headspace have no headspace or bubble that is <6mm (1/4").	Yes <input type="checkbox"/>	No <input type="checkbox"/>	No VOA vials submitted <input checked="" type="checkbox"/>
Water - pH acceptable upon receipt?	Yes <input type="checkbox"/>	No <input type="checkbox"/>	Not Applicable <input checked="" type="checkbox"/>

Standard Reporting Procedures:

Lab measurement of analytes considered field parameters that require analysis within 15 minutes of sampling such as pH, Dissolved Oxygen and Residual Chlorine, are qualified as being analyzed outside of recommended holding time.

Solid/soil samples are reported on a wet weight basis (as received) unless specifically indicated. If moisture corrected, data units are typically noted as –dry. For agricultural and mining soil parameters/characteristics, all samples are dried and ground prior to sample analysis.

The reference date for Radon analysis is the sample collection date. The reference date for all other Radiochemical analyses is the analysis date. Radiochemical precision results represent a 2-sigma Total Measurement Uncertainty.

Contact and Corrective Action Comments:

None



Chain of Custody and Analytical Request Record

PLEASE PRINT (Provide as much information as possible.)

Company Name: Woodard & Curran
 Report Mail Address (Required): 1015 S Montana St Suite C, Butte MT, 59701
 No Hard Copy Email: grcraig@woodardcurran.com
 Invoice Address (Required): 1800 Koch Suite A, Bozeman MT, 59715
 No Hard Copy Email: kbethke@woodardcurran.com

Project Name, PWS, Permit, Etc.: ARWW&S, RDU3, 0232257.03
 Sample Origin: State: MT
 EPA/State Compliance: Yes No
 Contact Name: Garrett Craig
 Phone/Fax: (406)291-2617
 Cell: (406)291-2617
 Sampler: (Please Print) Kristopher Bosch
 Purchase Order: [Blank]
 Quote/Bottle Order: [Blank]

SAMPLE IDENTIFICATION (Name, Location, Interval, etc.)	Collection Date	Collection Time	MATRIX	ANALYSIS REQUESTED		Standard Turnaround (TAT)	Comments:	Shipped by:
				SEE ATTACHED	Contact ELI prior to RUSH sample submittal for charges and scheduling - See Instruction Page			
1 22RDU3_SBL_018	07/12/2022	15:00	S	Number of Containers Air Water Vegetation DW - Drinking Water	✓			Receipt Temp: _____ °C On Ice: Y N Custody Seal On Bottle Y N On Cooler Y N Intact Y N Signature Match Y N
2 22RDU3_SBL_019	07/12/2022	15:05	S	B5361 - Lime Quality	✓			
3								
4								
5								
6								
7								
8								
9								
10								

Custody Record MUST be Signed

Relinquished by (print): Hannah Foster
 Relinquished by (print): Hannah Foster
 Date/Time: 07/13/22 12:00
 Date/Time: 07/13/22 12:00
 Signature: [Signature]

Received by (print): [Blank]
 Received by (print): [Blank]
 Date/Time: [Blank]
 Date/Time: [Blank]
 Signature: [Blank]
 Signature: [Blank]

Sample Disposal: [Blank] Return to Client: [Blank] Lab Disposal:
 Received by Laboratory: [Signature] Date/Time: 7-14-22 09:15

In certain circumstances, samples submitted to Energy Laboratories, Inc. may be subcontracted to other certified laboratories in order to complete the analysis requested. This serves as notice of this possibility. All sub-contract data will be clearly notated on your analytical report. Visit our web site at www.energylab.com for additional information, downloadable fee schedule, forms, and links.

ATTACHMENT C
FABRIC SPECIFICATION SHEET



GEOTEX[®] 801 is a polypropylene, staple fiber, needlepunched nonwoven geotextile produced by Propex, and will meet the following Minimum Average Roll Values (MARV) when tested in accordance with the methods listed below. The fibers are needed to form a stable network that retains dimensional stability relative to each other. The geotextile is resistant to ultraviolet degradation and to biological and chemical environments normally found in soils.

GEOTEX 801 conforms to the property values listed below¹. Propex performs internal Manufacturing Quality Control (MQC) tests that have been accredited by the Geosynthetic Accreditation Institute – Laboratory Accreditation Program (GAI-LAP). This product is NTPEP approved for AASHTO standards.

MARV ²			
PROPERTY	TEST METHOD	ENGLISH	METRIC
ORIGIN OF MATERIALS			
% U.S. Manufactured Inputs		100%	100%
% U.S. Manufactured		100%	100%
MECHANICAL			
Tensile Strength (Grab)	ASTM D-4632	205 lbs	912 N
Elongation	ASTM D-4632	50%	50%
CBR Puncture	ASTM D-6241	525 lbs	2336 N
Trapezoidal Tear	ASTM D-4533	80 lbs	356 N
ENDURANCE			
UV Resistance % Retained at 500 hrs	ASTM D-4355	70%	70%
HYDRAULIC			
Apparent Opening Size (AOS) ³	ASTM D-4751	80 US Std. Sieve	0.180 mm
Permittivity	ASTM D-4491	1.5 sec ⁻¹	1.5 sec ⁻¹
Water Flow Rate	ASTM D-4491	110 gpm/ft ²	4482 l/min/m ²
ROLL SIZES		12.5 ft x 360 ft 15 ft x 300 ft	3.81 m x 109.8 m 4.57 m x 91.5 m

NOTES:

1. The property values listed above are effective 04/2011 and are subject to change without notice.
2. Values shown are in weaker principal direction. Minimum average roll values (MARV) are calculated as the typical minus two standard deviations. Statistically, it yields a 97.7% degree of confidence that any samples taken from quality assurance testing will exceed the value reported.
3. Maximum average roll value.



TESTED. PROVEN. TRUSTED.
www.geotextile.com

Propex Operating Company, LLC · 6025 Lee Highway, Suite 425 · PO Box 22788 · Chattanooga, TN 37422

ph 423 899 0444 · ph 800 621 1273 · fax 423 899 7619

Geotex[®], Landlok[®], Pyramat[®], X3[®], SuperGro[®], Petromat[®] and Petrotac[®] are registered trademarks of Propex Operating Company, LLC.

This publication should not be construed as engineering advice. While information contained in this publication is accurate to the best of our knowledge, Propex does not warrant its accuracy or completeness. The ultimate customer and user of the products should assume sole responsibility for the final determination of the suitability of the information and the products for the contemplated and actual use. The only warranty made by Propex for its products is set forth in our product data sheets for the product, or such other written warranty as may be agreed by Propex and individual customers. Propex specifically disclaims all other warranties, express or implied, including without limitation, warranties of merchantability or fitness for a particular purpose, or arising from provision of samples, a course of dealing or usage of trade.

ATTACHMENT D
TYPE B MATERIAL BORROW STOCKPILE DATA

**APPENDIX D - TYPE B MATERIAL QA DATA
(From CS OU)**

Sample ID	Date Collected	Butte Hill Reveg Spec:	As	Cd	Cu	Pb	Zn	Hg
			< 97 mg/kg	< 4 mg/kg	< 250 mg/kg	< 100 mg/kg	< 250 mg/kg	< 5 mg/kg
1	20-CS-Type B-1203-001	Volume Tested: Approximatley 5,000 cy	5.8	0.08	10.9	4.7	21.7	-
2	20-CS-Type B-1203-002		4.5	0.10	12.3	4.9	25.8	-
3	20-CS-Type B-1203-003		3.4	Non Detect	8.7	4.7	19.4	-
4	20-CS-Type B-1203-004		8.3	0.13	17.2	6.3	29.7	-
5	20-CS-Type B-1203-005		7.7	0.11	16.8	7.1	29.9	-
6	20-CS-Type B-1203-006		7.8	0.10	14.6	5.9	28.2	-
7	20-CS-Type B-1203-007		10.9	0.09	13.7	5.4	25.7	-
8	20-CS-Type B-1203-008		5.0	0.11	10.5	4.8	23.5	-
9	20-CS-Type B-1203-009		10.1	0.11	18.2	6.7	31.7	-
10	20-CS-Type B-1203-010		5.7	0.09	12.6	5.5	26.2	-
11	20-CS-Type B-1203-011		3.9	Non Detect	8.6	4.0	20.8	-
12	20-CS-Type B-1203-012		3.8	0.09	8.9	5.3	26.7	-
13	21-TypeB-0817-001		-	-	-	-	-	0.02
14	21-TypeB-0817-002		-	-	-	-	-	0.02
15	21-TypeB-0817-003		-	-	-	-	-	0.01
16	21-TypeB-0817-004		-	-	-	-	-	0.02
	MAX:	10.9	0.13	18.2	7.1	31.7	0.02	
	MIN:	3.4	0.08	8.6	4.0	19.4	0.01	
	AVE:	6.4	0.10	12.8	5.4	25.8	0.02	

ATTACHMENT D-1
PACE ANALYTICAL DATA REPORTS

December 11, 2020

Jesse Schwarzrock
Pioneer Technical Services
307 E Park
Suite 421
Anaconda, MT 59711

RE: Project: CS OU Borrow Development
Pace Project No.: 10541146

Dear Jesse Schwarzrock:

Enclosed are the analytical results for sample(s) received by the laboratory on December 04, 2020. The results relate only to the samples included in this report. Results contained within this report conform to the most current version of the TNI standards, BP LaMP Technical Requirements Revision 12.1, and any applicable Quality Assurance Project Plan (QAPP), or Work Plan unless otherwise narrated in the body of this report.

The test results provided in this final report were generated by each of the following laboratories within the Pace Network:

- Pace Analytical Services - Minneapolis

If you have any questions concerning this report, please feel free to contact me.

Sincerely,



Jennifer Anderson
jennifer.anderson@pacelabs.com
(612)607-6436
Project Manager

Enclosures

cc: Jennifer Norman, Portage Inc.



REPORT OF LABORATORY ANALYSIS

This report shall not be reproduced, except in full,
without the written consent of Pace Analytical Services, LLC.

CERTIFICATIONS

Project: CS OU Borrow Development

Pace Project No.: 10541146

Pace Analytical Services - Minneapolis MN

1700 Elm Street SE, Minneapolis, MN 55414

1800 Elm Street SE, Minneapolis, MN 55414--Satellite Air Lab

A2LA Certification #: 2926.01*

Alabama Certification #: 40770

Alaska Contaminated Sites Certification #: 17-009*

Alaska DW Certification #: MN00064

Arizona Certification #: AZ0014*

Arkansas DW Certification #: MN00064

Arkansas WW Certification #: 88-0680

California Certification #: 2929

Colorado Certification #: MN00064

Connecticut Certification #: PH-0256

EPA Region 8+Wyoming DW Certification #: via MN 027-053-137

Florida Certification #: E87605*

Georgia Certification #: 959

Hawaii Certification #: MN00064

Idaho Certification #: MN00064

Illinois Certification #: 200011

Indiana Certification #: C-MN-01

Iowa Certification #: 368

Kansas Certification #: E-10167

Kentucky DW Certification #: 90062

Kentucky WW Certification #: 90062

Louisiana DEQ Certification #: AI-03086*

Louisiana DW Certification #: MN00064

Maine Certification #: MN00064*

Maryland Certification #: 322

Massachusetts DWP Certification #: via MN 027-053-137

Michigan Certification #: 9909

Minnesota Certification #: 027-053-137*

Minnesota Dept of Ag Certification #: via MN 027-053-137

Minnesota Petrofund Certification #: 1240*

Mississippi Certification #: MN00064

Missouri Certification #: 10100

Montana Certification #: CERT0092

Nebraska Certification #: NE-OS-18-06

Nevada Certification #: MN00064

New Hampshire Certification #: 2081*

New Jersey Certification #: MN002

New York Certification #: 11647*

North Carolina DW Certification #: 27700

North Carolina WW Certification #: 530

North Dakota Certification #: R-036

Ohio DW Certification #: 41244

Ohio VAP Certification #: CL101

Oklahoma Certification #: 9507*

Oregon Primary Certification #: MN300001

Oregon Secondary Certification #: MN200001*

Pennsylvania Certification #: 68-00563*

Puerto Rico Certification #: MN00064

South Carolina Certification #: 74003001

Tennessee Certification #: TN02818

Texas Certification #: T104704192*

Utah Certification #: MN00064*

Vermont Certification #: VT-027053137

Virginia Certification #: 460163*

Washington Certification #: C486*

West Virginia DEP Certification #: 382

West Virginia DW Certification #: 9952 C

Wisconsin Certification #: 999407970

Wyoming UST Certification #: via A2LA 2926.01

USDA Permit #: P330-19-00208

Please Note: Applicable air certifications are denoted with an asterisk ().

REPORT OF LABORATORY ANALYSIS

This report shall not be reproduced, except in full,
without the written consent of Pace Analytical Services, LLC.

SAMPLE SUMMARY

Project: CS OU Borrow Development

Pace Project No.: 10541146

Lab ID	Sample ID	Matrix	Date Collected	Date Received
10541146001	20-CS-TypeB-1203-001	Solid	12/03/20 10:30	12/04/20 10:40
10541146002	20-CS-TypeB-1203-002	Solid	12/03/20 10:35	12/04/20 10:40
10541146003	20-CS-TypeB-1203-003	Solid	12/03/20 10:40	12/04/20 10:40
10541146004	20-CS-TypeB-1203-004	Solid	12/03/20 10:45	12/04/20 10:40
10541146005	20-CS-TypeB-1203-005	Solid	12/03/20 10:50	12/04/20 10:40
10541146006	20-CS-TypeB-1203-006	Solid	12/03/20 10:55	12/04/20 10:40
10541146007	20-CS-TypeB-1203-007	Solid	12/03/20 11:00	12/04/20 10:40
10541146008	20-CS-TypeB-1203-008	Solid	12/03/20 11:05	12/04/20 10:40
10541146009	20-CS-TypeB-1203-009	Solid	12/03/20 11:10	12/04/20 10:40
10541146010	20-CS-TypeB-1203-010	Solid	12/03/20 11:15	12/04/20 10:40
10541146011	20-CS-TypeB-1203-011	Solid	12/03/20 11:20	12/04/20 10:40
10541146012	20-CS-TypeB-1203-012	Solid	12/03/20 11:25	12/04/20 10:40

REPORT OF LABORATORY ANALYSIS

This report shall not be reproduced, except in full,
without the written consent of Pace Analytical Services, LLC.

SAMPLE ANALYTE COUNT

Project: CS OU Borrow Development

Pace Project No.: 10541146

Lab ID	Sample ID	Method	Analysts	Analytes Reported	Laboratory
10541146001	20-CS-TypeB-1203-001	EPA 6020A	RJS	5	PASI-M
10541146002	20-CS-TypeB-1203-002	EPA 6020A	RJS	5	PASI-M
10541146003	20-CS-TypeB-1203-003	EPA 6020A	RJS	5	PASI-M
10541146004	20-CS-TypeB-1203-004	EPA 6020A	RJS	5	PASI-M
10541146005	20-CS-TypeB-1203-005	EPA 6020A	RJS	5	PASI-M
10541146006	20-CS-TypeB-1203-006	EPA 6020A	RJS	5	PASI-M
10541146007	20-CS-TypeB-1203-007	EPA 6020A	RJS	5	PASI-M
10541146008	20-CS-TypeB-1203-008	EPA 6020A	RJS	5	PASI-M
10541146009	20-CS-TypeB-1203-009	EPA 6020A	RJS	5	PASI-M
10541146010	20-CS-TypeB-1203-010	EPA 6020A	RJS	5	PASI-M
10541146011	20-CS-TypeB-1203-011	EPA 6020A	RJS	5	PASI-M
10541146012	20-CS-TypeB-1203-012	EPA 6020A	RJS	5	PASI-M

PASI-M = Pace Analytical Services - Minneapolis

REPORT OF LABORATORY ANALYSIS

This report shall not be reproduced, except in full,
without the written consent of Pace Analytical Services, LLC.

PROJECT NARRATIVE

Project: CS OU Borrow Development

Pace Project No.: 10541146

Method: EPA 6020A

Description: 6020A MET ICPMS

Client: BPAR-PIONEER-MT

Date: December 11, 2020

General Information:

12 samples were analyzed for EPA 6020A by Pace Analytical Services Minneapolis. All samples were received in acceptable condition with any exceptions noted below or on the chain-of custody and/or the sample condition upon receipt form (SCUR) attached at the end of this report.

Hold Time:

The samples were analyzed within the method required hold times with any exceptions noted below.

Sample Preparation:

The samples were prepared in accordance with EPA 3050B with any exceptions noted below.

Initial Calibrations (including MS Tune as applicable):

All criteria were within method requirements with any exceptions noted below.

Continuing Calibration:

All criteria were within method requirements with any exceptions noted below.

Internal Standards:

All internal standards were within QC limits with any exceptions noted below.

Method Blank:

All analytes were below the report limit in the method blank, where applicable, with any exceptions noted below.

Laboratory Control Spike:

All laboratory control spike compounds were within QC limits with any exceptions noted below.

Matrix Spikes:

All percent recoveries and relative percent differences (RPDs) were within acceptance criteria with any exceptions noted below.

Additional Comments:

This data package has been reviewed for quality and completeness and is approved for release.

REPORT OF LABORATORY ANALYSIS

This report shall not be reproduced, except in full,
without the written consent of Pace Analytical Services, LLC.

ANALYTICAL RESULTS

Project: CS OU Borrow Development

Pace Project No.: 10541146

Sample: 20-CS-TypeB-1203-001 **Lab ID: 10541146001** Collected: 12/03/20 10:30 Received: 12/04/20 10:40 Matrix: Solid

Results reported on a "wet-weight" basis

Parameters	Results	Units	Report Limit	DF	Prepared	Analyzed	CAS No.	Qual
6020A MET ICPMS		Analytical Method: EPA 6020A Preparation Method: EPA 3050B Pace Analytical Services - Minneapolis						
Arsenic	5.8	mg/kg	0.49	20	12/08/20 16:12	12/10/20 14:13	7440-38-2	
Cadmium	0.081	mg/kg	0.078	20	12/08/20 16:12	12/10/20 14:13	7440-43-9	
Copper	10.9	mg/kg	0.98	20	12/08/20 16:12	12/10/20 14:13	7440-50-8	
Lead	4.7	mg/kg	0.20	20	12/08/20 16:12	12/10/20 14:13	7439-92-1	
Zinc	21.7	mg/kg	4.9	20	12/08/20 16:12	12/10/20 14:13	7440-66-6	

REPORT OF LABORATORY ANALYSIS

This report shall not be reproduced, except in full,
without the written consent of Pace Analytical Services, LLC.

ANALYTICAL RESULTS

Project: CS OU Borrow Development

Pace Project No.: 10541146

Sample: 20-CS-TypeB-1203-002 Lab ID: 10541146002 Collected: 12/03/20 10:35 Received: 12/04/20 10:40 Matrix: Solid

Results reported on a "wet-weight" basis

Parameters	Results	Units	Report Limit	DF	Prepared	Analyzed	CAS No.	Qual
6020A MET ICPMS		Analytical Method: EPA 6020A Preparation Method: EPA 3050B Pace Analytical Services - Minneapolis						
Arsenic	4.5	mg/kg	0.46	20	12/08/20 16:12	12/10/20 14:29	7440-38-2	
Cadmium	0.10	mg/kg	0.074	20	12/08/20 16:12	12/10/20 14:29	7440-43-9	
Copper	12.3	mg/kg	0.93	20	12/08/20 16:12	12/10/20 14:29	7440-50-8	
Lead	4.9	mg/kg	0.19	20	12/08/20 16:12	12/10/20 14:29	7439-92-1	
Zinc	25.8	mg/kg	4.6	20	12/08/20 16:12	12/10/20 14:29	7440-66-6	

REPORT OF LABORATORY ANALYSIS

This report shall not be reproduced, except in full,
without the written consent of Pace Analytical Services, LLC.

ANALYTICAL RESULTS

Project: CS OU Borrow Development

Pace Project No.: 10541146

Sample: 20-CS-TypeB-1203-003 Lab ID: 10541146003 Collected: 12/03/20 10:40 Received: 12/04/20 10:40 Matrix: Solid

Results reported on a "wet-weight" basis

Parameters	Results	Units	Report Limit	DF	Prepared	Analyzed	CAS No.	Qual
6020A MET ICPMS		Analytical Method: EPA 6020A Preparation Method: EPA 3050B Pace Analytical Services - Minneapolis						
Arsenic	3.4	mg/kg	0.49	20	12/08/20 16:12	12/10/20 14:32	7440-38-2	
Cadmium	ND	mg/kg	0.078	20	12/08/20 16:12	12/10/20 14:32	7440-43-9	
Copper	8.7	mg/kg	0.98	20	12/08/20 16:12	12/10/20 14:32	7440-50-8	
Lead	4.7	mg/kg	0.20	20	12/08/20 16:12	12/10/20 14:32	7439-92-1	
Zinc	19.4	mg/kg	4.9	20	12/08/20 16:12	12/10/20 14:32	7440-66-6	

REPORT OF LABORATORY ANALYSIS

This report shall not be reproduced, except in full,
without the written consent of Pace Analytical Services, LLC.

ANALYTICAL RESULTS

Project: CS OU Borrow Development

Pace Project No.: 10541146

Sample: 20-CS-TypeB-1203-004 **Lab ID: 10541146004** Collected: 12/03/20 10:45 Received: 12/04/20 10:40 Matrix: Solid

Results reported on a "wet-weight" basis

Parameters	Results	Units	Report Limit	DF	Prepared	Analyzed	CAS No.	Qual
6020A MET ICPMS		Analytical Method: EPA 6020A Preparation Method: EPA 3050B Pace Analytical Services - Minneapolis						
Arsenic	8.3	mg/kg	0.47	20	12/08/20 16:12	12/10/20 14:41	7440-38-2	
Cadmium	0.13	mg/kg	0.075	20	12/08/20 16:12	12/10/20 14:41	7440-43-9	
Copper	17.2	mg/kg	0.94	20	12/08/20 16:12	12/10/20 14:41	7440-50-8	
Lead	6.3	mg/kg	0.19	20	12/08/20 16:12	12/10/20 14:41	7439-92-1	
Zinc	29.7	mg/kg	4.7	20	12/08/20 16:12	12/10/20 14:41	7440-66-6	

REPORT OF LABORATORY ANALYSIS

This report shall not be reproduced, except in full,
without the written consent of Pace Analytical Services, LLC.

ANALYTICAL RESULTS

Project: CS OU Borrow Development

Pace Project No.: 10541146

Sample: 20-CS-TypeB-1203-005 **Lab ID: 10541146005** Collected: 12/03/20 10:50 Received: 12/04/20 10:40 Matrix: Solid

Results reported on a "wet-weight" basis

Parameters	Results	Units	Report Limit	DF	Prepared	Analyzed	CAS No.	Qual
6020A MET ICPMS		Analytical Method: EPA 6020A Preparation Method: EPA 3050B Pace Analytical Services - Minneapolis						
Arsenic	7.7	mg/kg	0.47	20	12/08/20 16:12	12/10/20 14:45	7440-38-2	
Cadmium	0.11	mg/kg	0.075	20	12/08/20 16:12	12/10/20 14:45	7440-43-9	
Copper	16.8	mg/kg	0.93	20	12/08/20 16:12	12/10/20 14:45	7440-50-8	
Lead	7.1	mg/kg	0.19	20	12/08/20 16:12	12/10/20 14:45	7439-92-1	
Zinc	29.9	mg/kg	4.7	20	12/08/20 16:12	12/10/20 14:45	7440-66-6	

REPORT OF LABORATORY ANALYSIS

This report shall not be reproduced, except in full,
without the written consent of Pace Analytical Services, LLC.

ANALYTICAL RESULTS

Project: CS OU Borrow Development

Pace Project No.: 10541146

Sample: 20-CS-TypeB-1203-006 **Lab ID: 10541146006** Collected: 12/03/20 10:55 Received: 12/04/20 10:40 Matrix: Solid

Results reported on a "wet-weight" basis

Parameters	Results	Units	Report Limit	DF	Prepared	Analyzed	CAS No.	Qual
6020A MET ICPMS		Analytical Method: EPA 6020A Preparation Method: EPA 3050B Pace Analytical Services - Minneapolis						
Arsenic	7.8	mg/kg	0.48	20	12/08/20 16:12	12/10/20 14:48	7440-38-2	
Cadmium	0.10	mg/kg	0.077	20	12/08/20 16:12	12/10/20 14:48	7440-43-9	
Copper	14.6	mg/kg	0.96	20	12/08/20 16:12	12/10/20 14:48	7440-50-8	
Lead	5.9	mg/kg	0.19	20	12/08/20 16:12	12/10/20 14:48	7439-92-1	
Zinc	28.2	mg/kg	4.8	20	12/08/20 16:12	12/10/20 14:48	7440-66-6	

REPORT OF LABORATORY ANALYSIS

This report shall not be reproduced, except in full,
without the written consent of Pace Analytical Services, LLC.

ANALYTICAL RESULTS

Project: CS OU Borrow Development

Pace Project No.: 10541146

Sample: 20-CS-TypeB-1203-007 **Lab ID: 10541146007** Collected: 12/03/20 11:00 Received: 12/04/20 10:40 Matrix: Solid

Results reported on a "wet-weight" basis

Parameters	Results	Units	Report Limit	DF	Prepared	Analyzed	CAS No.	Qual
6020A MET ICPMS		Analytical Method: EPA 6020A Preparation Method: EPA 3050B Pace Analytical Services - Minneapolis						
Arsenic	10.9	mg/kg	0.49	20	12/08/20 16:12	12/10/20 14:51	7440-38-2	
Cadmium	0.091	mg/kg	0.078	20	12/08/20 16:12	12/10/20 14:51	7440-43-9	
Copper	13.7	mg/kg	0.98	20	12/08/20 16:12	12/10/20 14:51	7440-50-8	
Lead	5.4	mg/kg	0.20	20	12/08/20 16:12	12/10/20 14:51	7439-92-1	
Zinc	25.7	mg/kg	4.9	20	12/08/20 16:12	12/10/20 14:51	7440-66-6	

REPORT OF LABORATORY ANALYSIS

This report shall not be reproduced, except in full,
without the written consent of Pace Analytical Services, LLC.

ANALYTICAL RESULTS

Project: CS OU Borrow Development

Pace Project No.: 10541146

Sample: 20-CS-TypeB-1203-008 **Lab ID: 10541146008** Collected: 12/03/20 11:05 Received: 12/04/20 10:40 Matrix: Solid

Results reported on a "wet-weight" basis

Parameters	Results	Units	Report Limit	DF	Prepared	Analyzed	CAS No.	Qual
6020A MET ICPMS		Analytical Method: EPA 6020A Preparation Method: EPA 3050B Pace Analytical Services - Minneapolis						
Arsenic	5.0	mg/kg	0.47	20	12/08/20 16:12	12/10/20 14:54	7440-38-2	
Cadmium	0.11	mg/kg	0.075	20	12/08/20 16:12	12/10/20 14:54	7440-43-9	
Copper	10.5	mg/kg	0.94	20	12/08/20 16:12	12/10/20 14:54	7440-50-8	
Lead	4.8	mg/kg	0.19	20	12/08/20 16:12	12/10/20 14:54	7439-92-1	
Zinc	23.5	mg/kg	4.7	20	12/08/20 16:12	12/10/20 14:54	7440-66-6	

REPORT OF LABORATORY ANALYSIS

This report shall not be reproduced, except in full,
without the written consent of Pace Analytical Services, LLC.

ANALYTICAL RESULTS

Project: CS OU Borrow Development

Pace Project No.: 10541146

Sample: 20-CS-TypeB-1203-009 **Lab ID: 10541146009** Collected: 12/03/20 11:10 Received: 12/04/20 10:40 Matrix: Solid

Results reported on a "wet-weight" basis

Parameters	Results	Units	Report Limit	DF	Prepared	Analyzed	CAS No.	Qual
6020A MET ICPMS		Analytical Method: EPA 6020A Preparation Method: EPA 3050B Pace Analytical Services - Minneapolis						
Arsenic	10.1	mg/kg	0.46	20	12/08/20 16:12	12/10/20 14:57	7440-38-2	
Cadmium	0.11	mg/kg	0.073	20	12/08/20 16:12	12/10/20 14:57	7440-43-9	
Copper	18.2	mg/kg	0.92	20	12/08/20 16:12	12/10/20 14:57	7440-50-8	
Lead	6.7	mg/kg	0.18	20	12/08/20 16:12	12/10/20 14:57	7439-92-1	
Zinc	31.7	mg/kg	4.6	20	12/08/20 16:12	12/10/20 14:57	7440-66-6	

REPORT OF LABORATORY ANALYSIS

This report shall not be reproduced, except in full,
without the written consent of Pace Analytical Services, LLC.

ANALYTICAL RESULTS

Project: CS OU Borrow Development

Pace Project No.: 10541146

Sample: 20-CS-TypeB-1203-010 **Lab ID: 10541146010** Collected: 12/03/20 11:15 Received: 12/04/20 10:40 Matrix: Solid

Results reported on a "wet-weight" basis

Parameters	Results	Units	Report Limit	DF	Prepared	Analyzed	CAS No.	Qual
6020A MET ICPMS		Analytical Method: EPA 6020A Preparation Method: EPA 3050B Pace Analytical Services - Minneapolis						
Arsenic	5.7	mg/kg	0.48	20	12/08/20 16:12	12/10/20 15:00	7440-38-2	
Cadmium	0.094	mg/kg	0.076	20	12/08/20 16:12	12/10/20 15:00	7440-43-9	
Copper	12.6	mg/kg	0.95	20	12/08/20 16:12	12/10/20 15:00	7440-50-8	
Lead	5.5	mg/kg	0.19	20	12/08/20 16:12	12/10/20 15:00	7439-92-1	
Zinc	26.2	mg/kg	4.8	20	12/08/20 16:12	12/10/20 15:00	7440-66-6	

REPORT OF LABORATORY ANALYSIS

This report shall not be reproduced, except in full,
without the written consent of Pace Analytical Services, LLC.

ANALYTICAL RESULTS

Project: CS OU Borrow Development

Pace Project No.: 10541146

Sample: 20-CS-TypeB-1203-011 **Lab ID: 10541146011** Collected: 12/03/20 11:20 Received: 12/04/20 10:40 Matrix: Solid

Results reported on a "wet-weight" basis

Parameters	Results	Units	Report Limit	DF	Prepared	Analyzed	CAS No.	Qual
6020A MET ICPMS		Analytical Method: EPA 6020A Preparation Method: EPA 3050B Pace Analytical Services - Minneapolis						
Arsenic	3.9	mg/kg	0.49	20	12/08/20 16:12	12/10/20 15:03	7440-38-2	
Cadmium	ND	mg/kg	0.078	20	12/08/20 16:12	12/10/20 15:03	7440-43-9	
Copper	8.6	mg/kg	0.97	20	12/08/20 16:12	12/10/20 15:03	7440-50-8	
Lead	4.0	mg/kg	0.19	20	12/08/20 16:12	12/10/20 15:03	7439-92-1	
Zinc	20.8	mg/kg	4.9	20	12/08/20 16:12	12/10/20 15:03	7440-66-6	

REPORT OF LABORATORY ANALYSIS

This report shall not be reproduced, except in full,
without the written consent of Pace Analytical Services, LLC.

ANALYTICAL RESULTS

Project: CS OU Borrow Development

Pace Project No.: 10541146

Sample: 20-CS-TypeB-1203-012 **Lab ID: 10541146012** Collected: 12/03/20 11:25 Received: 12/04/20 10:40 Matrix: Solid

Results reported on a "wet-weight" basis

Parameters	Results	Units	Report Limit	DF	Prepared	Analyzed	CAS No.	Qual
6020A MET ICPMS		Analytical Method: EPA 6020A Preparation Method: EPA 3050B Pace Analytical Services - Minneapolis						
Arsenic	3.8	mg/kg	0.48	20	12/08/20 16:12	12/10/20 15:06	7440-38-2	
Cadmium	0.094	mg/kg	0.077	20	12/08/20 16:12	12/10/20 15:06	7440-43-9	
Copper	8.9	mg/kg	0.96	20	12/08/20 16:12	12/10/20 15:06	7440-50-8	
Lead	5.3	mg/kg	0.19	20	12/08/20 16:12	12/10/20 15:06	7439-92-1	
Zinc	26.7	mg/kg	4.8	20	12/08/20 16:12	12/10/20 15:06	7440-66-6	

REPORT OF LABORATORY ANALYSIS

This report shall not be reproduced, except in full,
without the written consent of Pace Analytical Services, LLC.

QUALITY CONTROL DATA

Project: CS OU Borrow Development

Pace Project No.: 10541146

QC Batch:	714545	Analysis Method:	EPA 6020A
QC Batch Method:	EPA 3050B	Analysis Description:	6020A Solids UPD4
		Laboratory:	Pace Analytical Services - Minneapolis

Associated Lab Samples: 10541146001, 10541146002, 10541146003, 10541146004, 10541146005, 10541146006, 10541146007, 10541146008, 10541146009, 10541146010, 10541146011, 10541146012

METHOD BLANK: 3814382 Matrix: Solid

Associated Lab Samples: 10541146001, 10541146002, 10541146003, 10541146004, 10541146005, 10541146006, 10541146007, 10541146008, 10541146009, 10541146010, 10541146011, 10541146012

Parameter	Units	Blank Result	Reporting Limit	Analyzed	Qualifiers
Arsenic	mg/kg	ND	0.46	12/10/20 14:05	
Cadmium	mg/kg	ND	0.073	12/10/20 14:05	
Copper	mg/kg	ND	0.92	12/10/20 14:05	
Lead	mg/kg	ND	0.18	12/10/20 14:05	
Zinc	mg/kg	ND	4.6	12/10/20 14:05	

LABORATORY CONTROL SAMPLE: 3814383

Parameter	Units	Spike Conc.	LCS Result	LCS % Rec	% Rec Limits	Qualifiers
Arsenic	mg/kg	47.2	42.7	90	80-120	
Cadmium	mg/kg	47.2	44.1	93	80-120	
Copper	mg/kg	47.2	46.6	99	80-120	
Lead	mg/kg	47.2	46.7	99	80-120	
Zinc	mg/kg	47.2	45.0	95	80-120	

MATRIX SPIKE & MATRIX SPIKE DUPLICATE: 3814384 3814385

Parameter	Units	MS		MSD		MS % Rec	MSD % Rec	% Rec Limits	RPD	Max RPD	Qual
		10541146001 Result	Spike Conc.	Spike Conc.	Result						
Arsenic	mg/kg	5.8	47.2	49	43.7	47.4	80	85	75-125	8	20
Cadmium	mg/kg	0.081	47.2	49	41.6	45.2	88	92	75-125	8	20
Copper	mg/kg	10.9	47.2	49	54.3	59.1	92	98	75-125	9	20
Lead	mg/kg	4.7	47.2	49	47.3	52.3	90	97	75-125	10	20
Zinc	mg/kg	21.7	47.2	49	62.1	68.3	86	95	75-125	10	20

Results presented on this page are in the units indicated by the "Units" column except where an alternate unit is presented to the right of the result.

REPORT OF LABORATORY ANALYSIS

This report shall not be reproduced, except in full,
without the written consent of Pace Analytical Services, LLC.

QUALIFIERS

Project: CS OU Borrow Development

Pace Project No.: 10541146

DEFINITIONS

DF - Dilution Factor, if reported, represents the factor applied to the reported data due to dilution of the sample aliquot.

ND - Not Detected at or above adjusted reporting limit.

TNTC - Too Numerous To Count

J - Estimated concentration above the adjusted method detection limit and below the adjusted reporting limit.

MDL - Adjusted Method Detection Limit.

PQL - Practical Quantitation Limit.

RL - Reporting Limit - The lowest concentration value that meets project requirements for quantitative data with known precision and bias for a specific analyte in a specific matrix.

S - Surrogate

1,2-Diphenylhydrazine decomposes to and cannot be separated from Azobenzene using Method 8270. The result for each analyte is a combined concentration.

Consistent with EPA guidelines, unrounded data are displayed and have been used to calculate % recovery and RPD values.

LCS(D) - Laboratory Control Sample (Duplicate)

MS(D) - Matrix Spike (Duplicate)

DUP - Sample Duplicate

RPD - Relative Percent Difference

NC - Not Calculable.

SG - Silica Gel - Clean-Up

U - Indicates the compound was analyzed for, but not detected.

N-Nitrosodiphenylamine decomposes and cannot be separated from Diphenylamine using Method 8270. The result reported for each analyte is a combined concentration.

Pace Analytical is TNI accredited. Contact your Pace PM for the current list of accredited analytes.

TNI - The NELAC Institute.

REPORT OF LABORATORY ANALYSIS

This report shall not be reproduced, except in full,
without the written consent of Pace Analytical Services, LLC.

QUALITY CONTROL DATA CROSS REFERENCE TABLE

Project: CS OU Borrow Development

Pace Project No.: 10541146

Lab ID	Sample ID	QC Batch Method	QC Batch	Analytical Method	Analytical Batch
10541146001	20-CS-TypeB-1203-001	EPA 3050B	714545	EPA 6020A	714943
10541146002	20-CS-TypeB-1203-002	EPA 3050B	714545	EPA 6020A	714943
10541146003	20-CS-TypeB-1203-003	EPA 3050B	714545	EPA 6020A	714943
10541146004	20-CS-TypeB-1203-004	EPA 3050B	714545	EPA 6020A	714943
10541146005	20-CS-TypeB-1203-005	EPA 3050B	714545	EPA 6020A	714943
10541146006	20-CS-TypeB-1203-006	EPA 3050B	714545	EPA 6020A	714943
10541146007	20-CS-TypeB-1203-007	EPA 3050B	714545	EPA 6020A	714943
10541146008	20-CS-TypeB-1203-008	EPA 3050B	714545	EPA 6020A	714943
10541146009	20-CS-TypeB-1203-009	EPA 3050B	714545	EPA 6020A	714943
10541146010	20-CS-TypeB-1203-010	EPA 3050B	714545	EPA 6020A	714943
10541146011	20-CS-TypeB-1203-011	EPA 3050B	714545	EPA 6020A	714943
10541146012	20-CS-TypeB-1203-012	EPA 3050B	714545	EPA 6020A	714943

REPORT OF LABORATORY ANALYSIS

This report shall not be reproduced, except in full,
without the written consent of Pace Analytical Services, LLC.



Laboratory Management Program LaMP Chain of Custody Record

Page 1 of 1
 Req Due Date (mm/dd/yyyy): _____ Rush TAT: X No
 Lab Work Order Number: _____

BP Site Node Path: _____
 BP Facility No: _____

Lab Name: Pace Analytical Services
 Lab Address: 1700 Elm Street Minneapolis, MN 55414
 Lab PM: Jennifer Anderson
 Lab Phone: 612-807-1700
 Lab Shipping Acct:
 Lab Bottle Order No:
 Other Info: Profile: 35746, Line 3
 BP Project Manager (PM): Luke Pokorny
 BP PM Phone: 408-723-1832
 BP PM Email: luke.pokorny@bp.com

Facility Address:
 City, State, ZIP Code:
 Lead Regulatory Agency:
 California Global ID No.:
 Enfos Proposal No:
 Accounting Mode: Provision _____
 Stage: Activity:
 Consultant/Contractor: Pioneer Technical Services
 Consultant/Contractor Project No: CS OU Borrow Development
 Address: 307 E Park Suite 421, Anaconda MT, 59711
 Consultant/Contractor PM: Jesse Schwarzrock
 Phone: 406-897-0949 Email: jschwarzrock@pioneer-technical.com
 Email EDD To: Jesse Schwarzrock
 Invoice To: BP Contractor: X

Lab No.	Sample Description	Date	Time	Matrix				No. Containers / Preservative				Requested Analyses				Report Type & QC Level	Comments
				Soil / Solid	Water / Liquid	Air / Vapor	Is this location a well?	Total Number of Containers	Unpreserved	H2SO4	HNO3	HCl	Methanol	As, Cd, Cu, Pb, Zn by 6020	Standard		
20-CS-TypeB-1203-001		12/03/20	10:30	X				1								001	
20-CS-TypeB-1203-002		12/03/20	10:35	X				1								002	
20-CS-TypeB-1203-003		12/03/20	10:40	X				1								003	
20-CS-TypeB-1203-004		12/03/20	10:45	X				1								004	
20-CS-TypeB-1203-005		12/03/20	10:50	X				1								005	
20-CS-TypeB-1203-006		12/03/20	10:55	X				1								006	
20-CS-TypeB-1203-007		12/03/20	11:00	X				1								007	
20-CS-TypeB-1203-008		12/03/20	11:05	X				1								008	
20-CS-TypeB-1203-009		12/03/20	11:10	X				1								009	
20-CS-TypeB-1203-010		12/03/20	11:15	X				1								010	
20-CS-TypeB-1203-011		12/03/20	11:20	X				1								011	
20-CS-TypeB-1203-012		12/03/20	11:25	X				1								012	

Relinquished By / Affiliation: _____ Date: 12/3/20 Time: 11:30
 Accepted By / Affiliation: JRL POU Date: 12/4/20 Time: 1040
 Shipper's Name: Cole Dalassera
 Shipper's Company: Pioneer Technical Services
 Shipment Method: FedEx Overnight Ship Date: 12/3/20
 Shipment Tracking No: _____

Special Instructions:
 THIS LINE - LAB USE ONLY. Custody Seals In Place Yes / No
 Temp Blank Yes / No
 Cooler Temp on Receipt: 2.7 °F/C
 Trip Blank: Yes / No
 MS/MSD Sample Submitted: Yes / No

BP Remediation Mana

WO#: 10541146



Sample Condition Upon Receipt – ESI Tech Specs	Client Name: <u>BP - pioneer tech</u>	Project #:	<h1 style="margin: 0;">WO# : 10541146</h1> <p>PM: JMA Due Date: 12/18/20 CLIENT: BP-PIONEER</p>
Courier: <input checked="" type="checkbox"/> Fed Ex <input type="checkbox"/> UPS <input type="checkbox"/> USPS <input type="checkbox"/> Client <input type="checkbox"/> Pace <input type="checkbox"/> Speedee <input type="checkbox"/> Commercial		Tracking Number: <u>4278 9929 1428</u> See Exceptions <input type="checkbox"/> ENV-FRM-MIN4-0142	

Custody Seal on Cooler/Box Present? Yes No
 Seals Intact? Yes No
 Biological Tissue Frozen? Yes No N/A
Packing Material: Bubble Wrap Bubble Bags None Other: _____
 Temp Blank? Yes No
Thermometer: T1(0461) T2(1336) T3(0459)
 T4(0254) T5(0489)
 Type of Ice: Wet Blue None Dry Melted

Temp should be above freezing to 6°C	Cooler Temp Read w/temp blank: <u>2.5</u> °C	Average Corrected Temp (no temp blank only): _____ °C	<input type="checkbox"/> See Exceptions <input type="checkbox"/> 1 Container
Correction Factor: <u>+0.2</u>		Cooler Temp Corrected w/temp blank: <u>2.7</u> °C	

USDA Regulated Soil: (N/A, water sample/Other: _____)
 Date/Initials of Person Examining Contents: RJR 12/9/20
 Did samples originate in a quarantine zone within the United States: AL, AR, CA, FL, GA, ID, LA, MS, NC, NM, NY, OK, OR, SC, TN, TX or VA (check maps)? Yes No
 Did samples originate from a foreign source (internationally, including Hawaii and Puerto Rico)? Yes No
If Yes to either question, fill out a Regulated Soil Checklist (F-MN-Q-338) and include with SCUR/COC paperwork.

	COMMENTS:
Chain of Custody Present and Filled Out? <input checked="" type="checkbox"/> Yes <input type="checkbox"/> No	1.
Chain of Custody Relinquished? <input checked="" type="checkbox"/> Yes <input type="checkbox"/> No	2.
Sampler Name and/or Signature on COC? <input checked="" type="checkbox"/> Yes <input type="checkbox"/> No <input type="checkbox"/> N/A	3.
Samples Arrived within Hold Time? <input checked="" type="checkbox"/> Yes <input type="checkbox"/> No	4.
Short Hold Time Analysis (<72 hr)? <input type="checkbox"/> Yes <input checked="" type="checkbox"/> No	5. <input type="checkbox"/> Fecal Coliform <input type="checkbox"/> HPC <input type="checkbox"/> Total Coliform/E coli <input type="checkbox"/> BOD/cBOD <input type="checkbox"/> Hex Chrome <input type="checkbox"/> Turbidity <input type="checkbox"/> Nitrate <input type="checkbox"/> Nitrite <input type="checkbox"/> Orthophos <input type="checkbox"/>
Rush Turn Around Time Requested? <input checked="" type="checkbox"/> Yes <input type="checkbox"/> No	6.
Sufficient Sample Volume? <input checked="" type="checkbox"/> Yes <input type="checkbox"/> No	7.
Triple Volume Provided for MS/MSD (if more than 10 samples)? <input type="checkbox"/> Yes <input type="checkbox"/> No <input checked="" type="checkbox"/> N/A	
Correct Containers Used? <input checked="" type="checkbox"/> Yes <input type="checkbox"/> No	8. <u>plastic bags</u>
-Pace Containers Used? <input type="checkbox"/> Yes <input checked="" type="checkbox"/> No	
Containers Intact? <input checked="" type="checkbox"/> Yes <input type="checkbox"/> No	9.
Field Filtered Volume Received for Dissolved Tests? <input type="checkbox"/> Yes <input type="checkbox"/> No <input checked="" type="checkbox"/> N/A	10. Is sediment visible in the dissolved container? <input type="checkbox"/> Yes <input type="checkbox"/> No
Is sufficient information available to reconcile the samples to the COC? <input checked="" type="checkbox"/> Yes <input type="checkbox"/> No	11. If no, write ID/ Date/Time on Container Below: See Exception <input type="checkbox"/> ENV-FRM-MIN4-0142
Matrix: <input type="checkbox"/> Water <input checked="" type="checkbox"/> Soil <input type="checkbox"/> Oil <input type="checkbox"/> Other _____	12. Sample # <input type="checkbox"/> NaOH <input type="checkbox"/> HNO ₃ <input type="checkbox"/> H ₂ SO ₄ <input type="checkbox"/> Zinc Acetate Positive for Res. <input type="checkbox"/> Yes <input type="checkbox"/> No See Exception <input type="checkbox"/> Chlorine? pH Paper Lot# ENV-FRM-MIN4-0142 Res. Chlorine 0-6 Roll 0-6 Strip 0-14 Strip
All containers needing acid/base preservation have been checked? <input type="checkbox"/> Yes <input type="checkbox"/> No <input checked="" type="checkbox"/> N/A	
All containers needing preservation are found to be in compliance with EPA recommendation? (HNO ₃ , H ₂ SO ₄ , <2pH, NaOH >9 Sulfide, NaOH >10 Cyanide) <input type="checkbox"/> Yes <input type="checkbox"/> No <input checked="" type="checkbox"/> N/A	
Exceptions: VOA, Coliform, TOC/DOC Oil and Grease, DRO/8015 (water) and Dioxin/PFAS *If adding preservative to a container it must be added to associated field and equipment blanks (verify with PM first) <input type="checkbox"/> Yes <input type="checkbox"/> No <input checked="" type="checkbox"/> N/A	
Extra labels present on soil VOA or WIDRO containers? <input type="checkbox"/> Yes <input type="checkbox"/> No <input checked="" type="checkbox"/> N/A	13. See Exception <input type="checkbox"/> ENV-FRM-MIN4-0140
Headspace in VOA Vials (greater than 6mm)? <input type="checkbox"/> Yes <input type="checkbox"/> No <input checked="" type="checkbox"/> N/A	
3 Trip Blanks Present? <input type="checkbox"/> Yes <input type="checkbox"/> No <input checked="" type="checkbox"/> N/A	14. Pace Trip Blank Lot # (if purchased): _____
Trip Blank Custody Seals Present? <input type="checkbox"/> Yes <input type="checkbox"/> No <input checked="" type="checkbox"/> N/A	

Temp Log: Temp must be maintained at <6°C during login, record temp every 20 mins	CLIENT NOTIFICATION/RESOLUTION	Field Data Required? <input type="checkbox"/> Yes <input type="checkbox"/> No
Opened Time: <u>1158</u> Temp: <u>2.5</u> Corrected Temp: <u>2.7</u>	Person Contacted: _____	Date/Time: _____
Time: put in cooler	Comments/Resolution: _____	
Time: <u>1218</u> Temp: <u>3.3</u> Corrected Temp: <u>3.5</u>		

Project Manager Review: _____ Date: 12/07/2020
 Note: Whenever there is a discrepancy affecting North Carolina compliance samples, a copy of this form will be sent to the North Carolina DEHNR Certification Office (i.e. out of hold, incorrect preservative, out of temp, incorrect containers)

August 25, 2021

Jesse Schwarzrock
Pioneer Technical Services
307 E Park
Suite 421
Anaconda, MT 59711

RE: Project: BPSOU School Sampling
Pace Project No.: 10574925

Dear Jesse Schwarzrock:

Enclosed are the analytical results for sample(s) received by the laboratory on August 18, 2021. The results relate only to the samples included in this report. Results contained within this report conform to the most current version of the TNI standards, BP LaMP Technical Requirements Revision 12.1, and any applicable Quality Assurance Project Plan (QAPP), or Work Plan unless otherwise narrated in the body of this report.

The test results provided in this final report were generated by each of the following laboratories within the Pace Network:

- Pace Analytical Services - Minneapolis

If you have any questions concerning this report, please feel free to contact me.

Sincerely,



Jennifer Anderson
jennifer.anderson@pacelabs.com
(612)607-6436
Project Manager

Enclosures

cc: Lester Dupes, Environmental Standards
Alyssa Reed, Environmental Standards, Inc.



REPORT OF LABORATORY ANALYSIS

This report shall not be reproduced, except in full,
without the written consent of Pace Analytical Services, LLC.

CERTIFICATIONS

Project: BPSOU School Sampling

Pace Project No.: 10574925

Pace Analytical Services, LLC - Minneapolis MN

1700 Elm Street SE, Minneapolis, MN 55414

1800 Elm Street SE, Minneapolis, MN 55414--Satellite Air Lab

A2LA Certification #: 2926.01*

Alabama Certification #: 40770

Alaska Contaminated Sites Certification #: 17-009*

Alaska DW Certification #: MN00064

Arizona Certification #: AZ0014*

Arkansas DW Certification #: MN00064

Arkansas WW Certification #: 88-0680

California Certification #: 2929

Colorado Certification #: MN00064

Connecticut Certification #: PH-0256

EPA Region 8 Tribal Water Systems+Wyoming DW Certification #: via MN 027-053-137

Florida Certification #: E87605*

Georgia Certification #: 959

Hawaii Certification #: MN00064

Idaho Certification #: MN00064

Illinois Certification #: 200011

Indiana Certification #: C-MN-01

Iowa Certification #: 368

Kansas Certification #: E-10167

Kentucky DW Certification #: 90062

Kentucky WW Certification #: 90062

Louisiana DEQ Certification #: AI-03086*

Louisiana DW Certification #: MN00064

Maine Certification #: MN00064*

Maryland Certification #: 322

Michigan Certification #: 9909

Minnesota Certification #: 027-053-137*

Minnesota Dept of Ag Approval: via MN 027-053-137

Minnesota Petrofund Registration #: 1240*

Mississippi Certification #: MN00064

Missouri Certification #: 10100

Montana Certification #: CERT0092

Nebraska Certification #: NE-OS-18-06

Nevada Certification #: MN00064

New Hampshire Certification #: 2081*

New Jersey Certification #: MN002

New York Certification #: 11647*

North Carolina DW Certification #: 27700

North Carolina WW Certification #: 530

North Dakota Certification #: R-036

Ohio DW Certification #: 41244

Ohio VAP Certification (1700) #: CL101

Ohio VAP Certification (1800) #: CL110*

Oklahoma Certification #: 9507*

Oregon Primary Certification #: MN300001

Oregon Secondary Certification #: MN200001*

Pennsylvania Certification #: 68-00563*

Puerto Rico Certification #: MN00064

South Carolina Certification #: 74003001

Tennessee Certification #: TN02818

Texas Certification #: T104704192*

Utah Certification #: MN00064*

Vermont Certification #: VT-027053137

Virginia Certification #: 460163*

Washington Certification #: C486*

West Virginia DEP Certification #: 382

West Virginia DW Certification #: 9952 C

Wisconsin Certification #: 999407970

Wyoming UST Certification #: via A2LA 2926.01

USDA Permit #: P330-19-00208

Please Note: Applicable air certifications are denoted with an asterisk ().

REPORT OF LABORATORY ANALYSIS

This report shall not be reproduced, except in full,
without the written consent of Pace Analytical Services, LLC.

SAMPLE SUMMARY

Project: BPSOU School Sampling

Pace Project No.: 10574925

Lab ID	Sample ID	Matrix	Date Collected	Date Received
10574925001	21-TypeB-0817-001	Solid	08/17/21 11:20	08/18/21 08:50
10574925002	21-TypeB-0817-002	Solid	08/17/21 11:30	08/18/21 08:50
10574925003	21-TypeB-0817-003	Solid	08/17/21 11:40	08/18/21 08:50
10574925004	21-TypeB-0817-004	Solid	08/17/21 11:50	08/18/21 08:50

REPORT OF LABORATORY ANALYSIS

This report shall not be reproduced, except in full,
without the written consent of Pace Analytical Services, LLC.

SAMPLE ANALYTE COUNT

Project: BPSOU School Sampling

Pace Project No.: 10574925

Lab ID	Sample ID	Method	Analysts	Analytes Reported	Laboratory
10574925001	21-TypeB-0817-001	EPA 7471B	LMW	1	PASI-M
		ASTM D2974	JDL	1	PASI-M
10574925002	21-TypeB-0817-002	EPA 7471B	LMW	1	PASI-M
		ASTM D2974	JDL	1	PASI-M
10574925003	21-TypeB-0817-003	EPA 7471B	LMW	1	PASI-M
		ASTM D2974	JDL	1	PASI-M
10574925004	21-TypeB-0817-004	EPA 7471B	LMW	1	PASI-M
		ASTM D2974	JDL	1	PASI-M

PASI-M = Pace Analytical Services - Minneapolis

REPORT OF LABORATORY ANALYSIS

This report shall not be reproduced, except in full,
without the written consent of Pace Analytical Services, LLC.

PROJECT NARRATIVE

Project: BPSOU School Sampling

Pace Project No.: 10574925

Date: August 25, 2021

Samples analyzed for method 6020 arsenic and lead were analyzed after they were dried and sieved using a number 60 sieve.

REPORT OF LABORATORY ANALYSIS

This report shall not be reproduced, except in full,
without the written consent of Pace Analytical Services, LLC.

PROJECT NARRATIVE

Project: BPSOU School Sampling

Pace Project No.: 10574925

Method: EPA 7471B

Description: 7471B Mercury

Client: BPAR-PIONEER-MT

Date: August 25, 2021

General Information:

4 samples were analyzed for EPA 7471B by Pace Analytical Services Minneapolis. All samples were received in acceptable condition with any exceptions noted below or on the chain-of custody and/or the sample condition upon receipt form (SCUR) attached at the end of this report.

Hold Time:

The samples were analyzed within the method required hold times with any exceptions noted below.

Sample Preparation:

The samples were prepared in accordance with EPA 7471B with any exceptions noted below.

Initial Calibrations (including MS Tune as applicable):

All criteria were within method requirements with any exceptions noted below.

Continuing Calibration:

All criteria were within method requirements with any exceptions noted below.

Method Blank:

All analytes were below the report limit in the method blank, where applicable, with any exceptions noted below.

Laboratory Control Spike:

All laboratory control spike compounds were within QC limits with any exceptions noted below.

Matrix Spikes:

All percent recoveries and relative percent differences (RPDs) were within acceptance criteria with any exceptions noted below.

Duplicate Sample:

All duplicate sample results were within method acceptance criteria with any exceptions noted below.

Additional Comments:

This data package has been reviewed for quality and completeness and is approved for release.

REPORT OF LABORATORY ANALYSIS

This report shall not be reproduced, except in full,
without the written consent of Pace Analytical Services, LLC.

ANALYTICAL RESULTS

Project: BPSOU School Sampling

Pace Project No.: 10574925

Sample: 21-TypeB-0817-001 **Lab ID: 10574925001** Collected: 08/17/21 11:20 Received: 08/18/21 08:50 Matrix: Solid

Results reported on a "dry weight" basis and are adjusted for percent moisture, sample size and any dilutions.

Parameters	Results	Units	PQL	MDL	DF	Prepared	Analyzed	CAS No.	Qual
7471B Mercury	Analytical Method: EPA 7471B Preparation Method: EPA 7471B Pace Analytical Services - Minneapolis								
Mercury	0.018	mg/kg	0.018	0.0077	1	08/23/21 17:49	08/25/21 14:51	7439-97-6	
Dry Weight / %M by ASTM D2974	Analytical Method: ASTM D2974 Pace Analytical Services - Minneapolis								
Percent Moisture	0.99	%	0.10	0.10	1		08/20/21 13:56		N2

REPORT OF LABORATORY ANALYSIS

This report shall not be reproduced, except in full,
without the written consent of Pace Analytical Services, LLC.

ANALYTICAL RESULTS

Project: BPSOU School Sampling

Pace Project No.: 10574925

Sample: 21-TypeB-0817-002 **Lab ID: 10574925002** Collected: 08/17/21 11:30 Received: 08/18/21 08:50 Matrix: Solid

Results reported on a "dry weight" basis and are adjusted for percent moisture, sample size and any dilutions.

Parameters	Results	Units	PQL	MDL	DF	Prepared	Analyzed	CAS No.	Qual
7471B Mercury	Analytical Method: EPA 7471B Preparation Method: EPA 7471B Pace Analytical Services - Minneapolis								
Mercury	0.017	mg/kg	0.017	0.0073	1	08/23/21 17:49	08/25/21 14:57	7439-97-6	
Dry Weight / %M by ASTM D2974	Analytical Method: ASTM D2974 Pace Analytical Services - Minneapolis								
Percent Moisture	1.4	%	0.10	0.10	1		08/20/21 13:56		N2

REPORT OF LABORATORY ANALYSIS

This report shall not be reproduced, except in full,
without the written consent of Pace Analytical Services, LLC.

ANALYTICAL RESULTS

Project: BPSOU School Sampling

Pace Project No.: 10574925

Sample: 21-TypeB-0817-003 **Lab ID: 10574925003** Collected: 08/17/21 11:40 Received: 08/18/21 08:50 Matrix: Solid

Results reported on a "dry weight" basis and are adjusted for percent moisture, sample size and any dilutions.

Parameters	Results	Units	PQL	MDL	DF	Prepared	Analyzed	CAS No.	Qual
7471B Mercury	Analytical Method: EPA 7471B Preparation Method: EPA 7471B Pace Analytical Services - Minneapolis								
Mercury	0.013J	mg/kg	0.020	0.0088	1	08/23/21 17:49	08/25/21 14:59	7439-97-6	
Dry Weight / %M by ASTM D2974	Analytical Method: ASTM D2974 Pace Analytical Services - Minneapolis								
Percent Moisture	1.1	%	0.10	0.10	1		08/20/21 13:56		N2

REPORT OF LABORATORY ANALYSIS

This report shall not be reproduced, except in full,
without the written consent of Pace Analytical Services, LLC.

ANALYTICAL RESULTS

Project: BPSOU School Sampling

Pace Project No.: 10574925

Sample: 21-TypeB-0817-004 **Lab ID: 10574925004** Collected: 08/17/21 11:50 Received: 08/18/21 08:50 Matrix: Solid

Results reported on a "dry weight" basis and are adjusted for percent moisture, sample size and any dilutions.

Parameters	Results	Units	PQL	MDL	DF	Prepared	Analyzed	CAS No.	Qual
7471B Mercury	Analytical Method: EPA 7471B Preparation Method: EPA 7471B Pace Analytical Services - Minneapolis								
Mercury	0.018J	mg/kg	0.020	0.0088	1	08/23/21 17:49	08/25/21 15:01	7439-97-6	
Dry Weight / %M by ASTM D2974	Analytical Method: ASTM D2974 Pace Analytical Services - Minneapolis								
Percent Moisture	1.1	%	0.10	0.10	1		08/20/21 13:57		N2

REPORT OF LABORATORY ANALYSIS

This report shall not be reproduced, except in full,
without the written consent of Pace Analytical Services, LLC.

QUALITY CONTROL DATA

Project: BPSOU School Sampling

Pace Project No.: 10574925

QC Batch:	765313	Analysis Method:	EPA 7471B
QC Batch Method:	EPA 7471B	Analysis Description:	7471B Mercury Solids
		Laboratory:	Pace Analytical Services - Minneapolis

Associated Lab Samples: 10574925001, 10574925002, 10574925003, 10574925004

METHOD BLANK: 4079252 Matrix: Solid
Associated Lab Samples: 10574925001, 10574925002, 10574925003, 10574925004

Parameter	Units	Blank Result	Reporting Limit	MDL	Analyzed	Qualifiers
Mercury	mg/kg	<0.0079	0.018	0.0079	08/25/21 14:48	

LABORATORY CONTROL SAMPLE: 4079253

Parameter	Units	Spike Conc.	LCS Result	LCS % Rec	% Rec Limits	Qualifiers
Mercury	mg/kg	0.47	0.48	102	80-120	

MATRIX SPIKE & MATRIX SPIKE DUPLICATE: 4079254 4079255

Parameter	Units	10574925001 Result	MS Spike Conc.	MSD Spike Conc.	MS Result	MSD Result	MS % Rec	MSD % Rec	% Rec Limits	RPD	Max RPD	Qual
Mercury	mg/kg	0.018	0.48	0.5	0.51	0.51	100	98	80-120	1	20	

SAMPLE DUPLICATE: 4079256

Parameter	Units	10574925001 Result	Dup Result	RPD	Max RPD	Qualifiers
Mercury	mg/kg	0.018	0.018	0	20	

Results presented on this page are in the units indicated by the "Units" column except where an alternate unit is presented to the right of the result.

REPORT OF LABORATORY ANALYSIS

This report shall not be reproduced, except in full, without the written consent of Pace Analytical Services, LLC.

QUALITY CONTROL DATA

Project: BPSOU School Sampling

Pace Project No.: 10574925

QC Batch:	764856	Analysis Method:	ASTM D2974
QC Batch Method:	ASTM D2974	Analysis Description:	Dry Weight / %M by ASTM D2974
		Laboratory:	Pace Analytical Services - Minneapolis

Associated Lab Samples: 10574925001, 10574925002, 10574925003, 10574925004

SAMPLE DUPLICATE: 4077836

Parameter	Units	10574920001 Result	Dup Result	RPD	Max RPD	Qualifiers
Percent Moisture	%	16.2	17.7	9	30	N2

SAMPLE DUPLICATE: 4077837

Parameter	Units	10574716004 Result	Dup Result	RPD	Max RPD	Qualifiers
Percent Moisture	%	19.4	21.0	8	30	N2

Results presented on this page are in the units indicated by the "Units" column except where an alternate unit is presented to the right of the result.

REPORT OF LABORATORY ANALYSIS

This report shall not be reproduced, except in full,
without the written consent of Pace Analytical Services, LLC.

QUALIFIERS

Project: BPSOU School Sampling

Pace Project No.: 10574925

DEFINITIONS

DF - Dilution Factor, if reported, represents the factor applied to the reported data due to dilution of the sample aliquot.

ND - Not Detected at or above adjusted reporting limit.

TNTC - Too Numerous To Count

J - Estimated concentration above the adjusted method detection limit and below the adjusted reporting limit.

MDL - Adjusted Method Detection Limit.

PQL - Practical Quantitation Limit.

RL - Reporting Limit - The lowest concentration value that meets project requirements for quantitative data with known precision and bias for a specific analyte in a specific matrix.

S - Surrogate

1,2-Diphenylhydrazine decomposes to and cannot be separated from Azobenzene using Method 8270. The result for each analyte is a combined concentration.

Consistent with EPA guidelines, unrounded data are displayed and have been used to calculate % recovery and RPD values.

LCS(D) - Laboratory Control Sample (Duplicate)

MS(D) - Matrix Spike (Duplicate)

DUP - Sample Duplicate

RPD - Relative Percent Difference

NC - Not Calculable.

SG - Silica Gel - Clean-Up

U - Indicates the compound was analyzed for, but not detected.

N-Nitrosodiphenylamine decomposes and cannot be separated from Diphenylamine using Method 8270. The result reported for each analyte is a combined concentration.

Pace Analytical is TNI accredited. Contact your Pace PM for the current list of accredited analytes.

TNI - The NELAC Institute.

ANALYTE QUALIFIERS

N2 The lab does not hold NELAC/TNI accreditation for this parameter but other accreditations/certifications may apply. A complete list of accreditations/certifications is available upon request.

REPORT OF LABORATORY ANALYSIS

This report shall not be reproduced, except in full,
without the written consent of Pace Analytical Services, LLC.

QUALITY CONTROL DATA CROSS REFERENCE TABLE

Project: BPSOU School Sampling

Pace Project No.: 10574925

Lab ID	Sample ID	QC Batch Method	QC Batch	Analytical Method	Analytical Batch
10574925001	21-TypeB-0817-001	EPA 7471B	765313	EPA 7471B	765752
10574925002	21-TypeB-0817-002	EPA 7471B	765313	EPA 7471B	765752
10574925003	21-TypeB-0817-003	EPA 7471B	765313	EPA 7471B	765752
10574925004	21-TypeB-0817-004	EPA 7471B	765313	EPA 7471B	765752
10574925001	21-TypeB-0817-001	ASTM D2974	764856		
10574925002	21-TypeB-0817-002	ASTM D2974	764856		
10574925003	21-TypeB-0817-003	ASTM D2974	764856		
10574925004	21-TypeB-0817-004	ASTM D2974	764856		

REPORT OF LABORATORY ANALYSIS

This report shall not be reproduced, except in full,
without the written consent of Pace Analytical Services, LLC.



Laboratory Management Program LAMP Chain of Custody Record

Req Due Date (mm/dd/yy): _____
 Lab Work Order Number: _____

BP Site Node Path: _____
 BP Facility No: _____

Lab Name: Pace Analytical Services		Facility Address:		Consultant/Contractor: Pioneer Technical Services	
Lab Address: 1700 Elm Street Minneapolis, MN 55414		City, State, ZIP Code:		Consultant/Contractor Project No: BPSOU School Sampling	
Lab PM: Jennifer Anderson		Lead Regulatory Agency:		Address: 307 E Park Suite 421, Anaconda MT, 59711	
Lab Phone: 612-607-1700		California Global ID No.:		Consultant/Contractor PM: Jesse Schwarzrock	
Lab Shipping Acct:		Enfos Proposal No:		Phone: 406-697-0949 Email: jschwarzrock@pioneer-technical.com	
Lab Bottle Order No:		Accounting Mode:		Email EDD To: Jesse Schwarzrock	
Other Info:		Stage:		Invoice To: BP Contractor <input checked="" type="checkbox"/> X	
BP Project Manager (PM): Mike McAnulty		Matrix		Requested Analyses	
BP PM Phone: 406-723-1822		Total Number of Containers		Report Type & QC Level	
BP PM Email: mcanumc@bp.com		Is this location a well?		Standard <input type="checkbox"/> x	
		Air / Vapor		Full Data Package <input type="checkbox"/>	
		Water / Liquid		Note: If sample not collected, indicate "N/A"	
		Soil / Solid		Comments	
Lab No.	Sample Description	Date	Time	7471 Mercury, dry weight	
	21-TypeB-0817-001	08/17/21	1120	X	RUSH TURNAROUND
	21-TypeB-0817-002	08/17/21	1130	X	RUSH TURNAROUND
	21-TypeB-0817-003	08/17/21	1140	X	RUSH TURNAROUND
	21-TypeB-0817-004	08/17/21	1150	X	RUSH TURNAROUND
				WO# : 10574925 10574925	
Sampler's Name: Molly Sprunger		Relinquished By / Affiliation		Accepted By / Affiliation	
Sampler's Company: Pioneer Technical Services		Molly Sprunger / Pioneer		Molly Sprunger / Pca	
Shipment Method: FedEx Overnight		Date: 8/17/21		Date: 8/18/21	
Shipment Tracking No: 4278 9935 1703		Time: 12:45		Time: 8:50	
Special Instructions:					



Document Name: Sample Condition Upon Receipt (SCUR) - ESI

Document Revised: 12Aug2020

Document No.: ENV-FRM-MIN4-0149 Rev.01

Page 1 of 1 Pace Analytical Services - Minneapolis

Sample Condition Upon Receipt - ESI Tech Specs

Client Name:

Project #:

WO#: 10574925

PM: JMA

Due Date: 08/25/21

CLIENT: BP-PIONEER

Courier: Fed Ex, UPS, USPS, Client, Pace, Speedee, Commercial

Tracking Number: 4278 9935 1703

See Exceptions ENV-FRM-MIN4-0142

Custody Seal on Cooler/Box Present? Yes No, Seals Intact? Yes No, Biological Tissue Frozen? Yes No N/A

Packing Material: Bubble Wrap, Bubble Bags, None, Other, Temp Blank? Yes No

Thermometer: T1(0461), T2(1336), T3(0459), T4(0254), T5(0489), Type of Ice: Wet, Blue, None, Dry, Melted

Temp should be above freezing to 6°C, Cooler Temp Read w/temp blank: 5.4 °C, Average Corrected Temp (no temp blank): 5.4 °C, Correction Factor: True

USDA Regulated Soil: (N/A, water sample/Other:), Date/Initials of Person Examining Contents: HKB 8/18/21, Did samples originate in a quarantine zone within the United States: AL, AR, CA, FL, GA, ID, LA, MS, NC, NM, NY, OK, OR, SC, TN, TX or VA (check maps)? Yes No, Did samples originate from a foreign source (internationally, including Hawaii and Puerto Rico)? Yes No

If Yes to either question, fill out a Regulated Soil Checklist (F-MN-Q-338) and include with SCUR/COC paperwork.

Table with 2 columns: Question and COMMENTS. Contains 14 numbered rows of questions and checkboxes regarding sample handling, custody, and analysis.

Temp Log: Temp must be maintained at <6°C during login, record temp every 20 mins. Opened Time: 11:30, Temp: 5.4, Corrected Temp: 5.4. Time: 11:45 put in cooler. Time: JMA 8/19/21, Temp: , Corrected Temp:

CLIENT NOTIFICATION/RESOLUTION. Field Data Required? Yes No. Person Contacted: , Date/Time: . Comments/Resolution:

Project Manager Review:

Date: 08/19/2021

Note: Whenever there is a discrepancy affecting North Carolina compliance samples, a copy of this form will be sent to the North Carolina DEHNR Certification Office (i.e out of hold, incorrect preservative, out of temp, incorrect containers)

Labeled by: HKB (2) [Signature]

ATTACHMENT E
AGENCY APPROVED KAW AVENUE
BORROW STOCKPILE DATA

BUTTE HILL COVER SOIL APPROVAL SUBMITTAL

8/21/2021

Source: Kaw Avenue Stockpile
 Sample #: BPSOU-KAW-1

Description	Specification			Specification Met		Other Information Requested
				Sample	Yes	
Chemical (mg/kg)						Organic Matter (%)
As	<	97	26.9	X		3.70
Cd	<	4	0.9	X		
Cu	<	250	66.9	X		Soil Nutrients
Hg	<	5	0.03	X		N (mg/kg) N/A
Pb	<	100	29.4	X		P (mg/kg) N/A
Zn	<	250	132.0	X		K (mg/kg) N/A
pH (s.u.)						
	>	5.5	7.9	X		
	<	8.5				
SAR	<	12	1.12	X		
Saturation (%)						
	<	85	42.7	X		
	>	25				
EC (mmhos/cm)	<	4	1.3	X		
Textural Classification (USDA) <2.0 mm						Particle Size
		Loam		X		Sand (%) 52
		Sandy loam				Silt (%) 28
		Sandy clay loam				Clay (%) 20
		Sandy clay				
		Clay loam				
		Silty clay				
		Silty clay loam				
		Silt loam				
		Silt				
		*Per EPA Approval (Loamy sand)				
Rock Content (%) (by volume)	<	45	13.1	X		

Legend:

# Value	- Criteria met
# Value	- Does not meet Criteria

Atlantic Richfield Representative: Mike McNulty Date: 8-21-21

EPA Representative: NIKIA GREENE Digitally signed by NIKIA GREENE Date: 2021.08.27 11:11:04 -06'00' Date: _____

MT DEQ Representative: Clay Reed Date: 8/27/2021

BUTTE HILL COVER SOIL APPROVAL SUBMITTAL

8/21/2021

Source: Kaw Avenue Stockpile
Sample #: BPSOU-KAW-2

Description	Specification Met			Specification		Other Information Requested
	Specification	Sample	Yes	No		
Chemical (mg/kg)						Organic Matter (%)
As	<	97	15.9	X		3.50
Cd	<	4	0.5	X		
Cu	<	250	36.2	X		
Hg	<	5	0.02	X		
Pb	<	100	16.0	X		
Zn	<	250	76.0	X		
pH (s.u.)						Soil Nutrients
	>	5.5	8.0	X		N (mg/kg) N/A
	<	8.5				P (mg/kg) N/A
						K (mg/kg) N/A
SAR						
	<	12	0.77	X		
Saturation (%)						
	<	85	43.7	X		
	>	25				
EC (mmhos/cm)						
	<	4	0.9	X		
Textural Classification (USDA) <2.0 mm						Particle Size
Loam			X			Sand (%) 44
Sandy loam						Silt (%) 32
Sandy clay loam						Clay (%) 24
Sandy clay						
Clay loam						
Silty clay						
Silty clay loam						
Silt loam						
Silt						
*Per EPA Approval (Loamy sand)						
Rock Content (%) (by volume)						
	<	45	17.3	X		

Legend:

# Value		- Criteria met
# Value		- Does not meet Criteria

Atlantic Richfield Representative: Mike McNulty Date: 8-21-21

EPA Representative: NIKIA GREENE Digitally signed by NIKIA GREENE Date: 2021.08.27 11:12:44 -06'00' Date: _____

MT DEQ Representative: Clay Reed Date: 8/27/2021

BUTTE HILL COVER SOIL APPROVAL SUBMITTAL

8/21/2021

Source: **Kaw Avenue Stockpile**
 Sample #: **BPSOU-KAW-3**

Specification Met

Description	Specification	Sample	Specification Met		Other Information Requested
			Yes	No	
Chemical (mg/kg)					Organic Matter (%)
As	< 97	29.8	X		3.60
Cd	< 4	0.8	X		
Cu	< 250	64.7	X		
Hg	< 5	0.02	X		
Pb	< 100	23.8	X		
Zn	< 250	103.0	X		
pH (s.u.)					Soil Nutrients
	> 5.5	7.8	X		N (mg/kg) N/A
	< 8.5				P (mg/kg) N/A
					K (mg/kg) N/A
SAR					
	< 12	0.78	X		
Saturation (%)					
	< 85	44.4	X		
	> 25				
EC (mmhos/cm)					
	< 4	1.5	X		
Textural Classification (USDA) <2.0 mm					Particle Size
Loam			X		Sand (%) 42
Sandy loam					Silt (%) 32
Sandy clay loam					Clay (%) 26
Sandy clay					
Clay loam					
Silty clay					
Silty clay loam					
Silt loam					
Silt					
*Per EPA Approval (Loamy sand)					
Rock Content (%) (by volume)					
	< 45	12.5	X		

Legend:

# Value	- Criteria met
# Value	- Does not meet Criteria

Atlantic Richfield Representative: Mike McNulty Date: 8-21-21

EPA Representative: NIKIA GREENE Digitally signed by NIKIA GREENE Date: 2021.08.27 11:16:08 -06'00' Date: _____

MT DEQ Representative: Clay Keel Date: 8/27/2021

BUTTE HILL COVER SOIL APPROVAL SUBMITTAL

8/21/2021

Source: **Kaw Avenue Stockpile**
 Sample #: **BPSOU-KAW-4**

Description	Specification	Sample	Specification Met		Other Information Requested
			Yes	No	
Chemical (mg/kg)					Organic Matter (%)
As	< 97	31.0	X		3.50
Cd	< 4	0.8	X		
Cu	< 250	77.9	X		
Hg	< 5	0.03	X		
Pb	< 100	26.6	X		
Zn	< 250	129.0	X		
pH (s.u.)					Soil Nutrients
	> 5.5	7.7	X		N (mg/kg) N/A
	< 8.5				P (mg/kg) N/A
					K (mg/kg) N/A
SAR					
	< 12	0.56	X		
Saturation (%)					
	< 85	49.4	X		
	> 25				
EC (mmhos/cm)					
	< 4	1.5	X		
Textural Classification (USDA) <2.0 mm					Particle Size
Loam					Sand (%) 34
Sandy loam					Silt (%) 38
Sandy clay loam					Clay (%) 28
Sandy clay					
Clay loam			X		
Silty clay					
Silty clay loam					
Silt loam					
Silt					
*Per EPA Approval (Loamy sand)					
Rock Content (%) (by volume)					
	< 45	12.2	X		

Legend:

# Value	- Criteria met
# Value	- Does not meet Criteria

Atlantic Richfield Representative: Mike McNulty Date: 8-21-21

EPA Representative: NIKIA GREENE Date: _____
Digitally signed by NIKIA GREENE Date: 2021.08.27 11:17:59 -0600

MT DEQ Representative: Clay Reed Date: 8/27/2021

BUTTE HILL COVER SOIL APPROVAL SUBMITTAL

8/21/2021

Source: **Kaw Avenue Stockpile**
 Sample #: **BPSOU-KAW-5**

Description	Specification	Sample	Specification Met		Other Information Requested
			Yes	No	
Chemical (mg/kg)					Organic Matter (%)
As	< 97	33.9	X		3.80
Cd	< 4	0.9	X		
Cu	< 250	78.2	X		Soil Nutrients
Hg	< 5	0.03	X		N (mg/kg)
Pb	< 100	26.9	X		P (mg/kg)
Zn	< 250	127.0	X		K (mg/kg)
					N/A
					N/A
					N/A
pH (s.u.)					
	> 5.5	7.8	X		
	< 8.5				
SAR					
	< 12	0.47	X		
Saturation (%)					
	< 85	52.2	X		
	> 25				
EC (mmhos/cm)					
	< 4	1.0	X		
Textural Classification (USDA) <2.0 mm					Particle Size
Loam					Sand (%)
Sandy loam					Silt (%)
Sandy clay loam					Clay (%)
Sandy clay					28
Clay loam			X		42
Silty clay					30
Silty clay loam					
Silt loam					
Silt					
*Per EPA Approval (Loamy sand)					
Rock Content (%) (by volume)					
	< 45	9.3	X		

Legend:

# Value	- Criteria met
# Value	- Does not meet Criteria

Atlantic Richfield Representative: Mike McNulty Date: 8-21-21

EPA Representative: NIKIA GREENE Digitally signed by NIKIA GREENE Date: 2021.08.27 11:19:54 -06'00' Date: _____

MT DEQ Representative: Clay Reed Date: 8/27/2021

BUTTE HILL COVER SOIL APPROVAL SUBMITTAL

8/21/2021

Source: **Kaw Avenue Stockpile**
 Sample #: **BPSOU-KAW-6**

Specification Met

Description	Specification	Sample	Specification Met		Other Information Requested
			Yes	No	
Chemical (mg/kg)					Organic Matter (%)
As	< 97	43.4	X		3.70
Cd	< 4	1.0	X		
Cu	< 250	99.3	X		Soil Nutrients
Hg	< 5	0.03	X		N (mg/kg) N/A
Pb	< 100	36.1	X		P (mg/kg) N/A
Zn	< 250	143.0	X		K (mg/kg) N/A
pH (s.u.)					
	> 5.5	7.9	X		
	< 8.5				
SAR					
	< 12	0.88	X		
Saturation (%)					
	< 85	49.2	X		
	> 25				
EC (mmhos/cm)					
	< 4	1.4	X		
Textural Classification (USDA) <2.0 mm					Particle Size
Loam			X		Sand (%) 34
Sandy loam					Silt (%) 40
Sandy clay loam					Clay (%) 26
Sandy clay					
Clay loam					
Silty clay					
Silty clay loam					
Silt loam					
Silt					
*Per EPA Approval (Loamy sand)					
Rock Content (%) (by volume)					
	< 45	11.0	X		

Legend:

# Value	- Criteria met
# Value	- Does not meet Criteria

Atlantic Richfield Representative: Mike McNulty Date: 8-21-21

EPA Representative: NIKIA GREENE Digitally signed by NIKIA GREENE Date: 2021.08.27 11:22:16 -06'00' Date: _____

MT DEQ Representative: Clay Reed Date: 8/27/2021

BUTTE HILL COVER SOIL APPROVAL SUBMITTAL

8/21/2021

Source: **Kaw Avenue Stockpile**
 Sample #: **BPSOU-KAW-7**

Description	Specification Met			Yes	No	Other Information Requested
	Specification	Sample	Value			
Chemical (mg/kg)						Organic Matter (%)
As	<	97	36.6	X		4.10
Cd	<	4	0.9	X		
Cu	<	250	85.7	X		Soil Nutrients
Hg	<	5	0.03	X		N (mg/kg)
Pb	<	100	28.8	X		P (mg/kg)
Zn	<	250	133.0	X		K (mg/kg)
						N/A
						N/A
						N/A
pH (s.u.)						
	>	5.5	7.5	X		
	<	8.5				
SAR						
	<	12	0.39	X		
Saturation (%)						
	<	85	49.3	X		
	>	25				
EC (mmhos/cm)						
	<	4	1.3	X		
Textural Classification (USDA) <2.0 mm						Particle Size
Loam						Sand (%)
Sandy loam						Silt (%)
Sandy clay loam						Clay (%)
Sandy clay						32
Clay loam				X		40
Silty clay						28
Silty clay loam						
Silt loam						
Silt						
*Per EPA Approval (Loamy sand)						
Rock Content (%) (by volume)						
	<	45	11.5	X		

Legend:

# Value		- Criteria met
# Value		- Does not meet Criteria

Atlantic Richfield Representative: Mike McNulty Date: 8-21-21

EPA Representative: NIKIA GREENE Digitally signed by NIKIA GREENE Date: 2021.08.27 11:24:49 -06'00' Date: _____

MT DEQ Representative: Clay Reed Date: 8/27/2021

BUTTE HILL COVER SOIL APPROVAL SUBMITTAL

8/21/2021

Source: **Kaw Avenue Stockpile**
 Sample #: **BPSOU-KAW-8**

Description	Specification	Sample	Specification Met		Other Information Requested
			Yes	No	
Chemical (mg/kg)					Organic Matter (%)
As	< 97	37.8	X		3.70
Cd	< 4	0.9	X		
Cu	< 250	82.9	X		
Hg	< 5	0.03	X		
Pb	< 100	27.5	X		
Zn	< 250	131.0	X		
pH (s.u.)					Soil Nutrients
	> 5.5	7.4	X		N (mg/kg) N/A
	< 8.5				P (mg/kg) N/A
					K (mg/kg) N/A
SAR					
	< 12	0.79	X		
Saturation (%)					
	< 85	45.7	X		
	> 25				
EC (mmhos/cm)					
	< 4	2.1	X		
Textural Classification (USDA) <2.0 mm					Particle Size
Loam			X		Sand (%) 46
Sandy loam					Silt (%) 28
Sandy clay loam					Clay (%) 26
Sandy clay					
Clay loam					
Silty clay					
Silty clay loam					
Silt loam					
Silt					
*Per EPA Approval (Loamy sand)					
Rock Content (%) (by volume)					
	< 45	12.2	X		

Legend:

# Value	- Criteria met
# Value	- Does not meet Criteria

Atlantic Richfield Representative: Mike McNulty Date: 8-21-21

EPA Representative: NIKIA GREENE Digitally signed by NIKIA GREENE Date: 2021.08.27 11:26:25 -06'00' Date: _____

MT DEQ Representative: Clay Reed Date: 8/27/2021

ATTACHMENT E-1
ENERGY LABS DATA REPORT



ANALYTICAL SUMMARY REPORT

August 20, 2021

Pioneer Technical Services
307 E Park Ste 421
Anaconda, MT 59711-2300

Work Order: B21081152 Quote ID: B5332

Project Name: BPSOU School Sampling

Energy Laboratories Inc Billings MT received the following 8 samples for Pioneer Technical Services on 8/12/2021 for analysis.

Lab ID	Client Sample ID	Collect Date	Receive Date	Matrix	Test
B21081152-001	BPSOU-KAW-1	08/10/21 12:30	08/12/21	Soil	Metals, Saturated Paste Conductivity, Saturated Paste Extract Organic Carbon/Matter Walkley-Black pH, Saturated Paste Saturated Paste Extraction ASA Particle Size Analysis / Texture Sodium Adsorption Ratio Saturation Percentage Sieve Analysis, Dry
B21081152-002	BPSOU-KAW-2	08/10/21 12:35	08/12/21	Soil	Same As Above
B21081152-003	BPSOU-KAW-3	08/10/21 12:40	08/12/21	Soil	Same As Above
B21081152-004	BPSOU-KAW-4	08/10/21 12:45	08/12/21	Soil	Same As Above
B21081152-005	BPSOU-KAW-5	08/10/21 12:50	08/12/21	Soil	Same As Above
B21081152-006	BPSOU-KAW-6	08/10/21 12:55	08/12/21	Soil	Same As Above
B21081152-007	BPSOU-KAW-7	08/10/21 13:00	08/12/21	Soil	Same As Above
B21081152-008	BPSOU-KAW-8	08/10/21 13:05	08/12/21	Soil	Same As Above

The analyses presented in this report were performed by Energy Laboratories, Inc., 1120 S 27th St., Billings, MT 59101, unless otherwise noted. Any exceptions or problems with the analyses are noted in the report package. Any issues encountered during sample receipt are documented in the Work Order Receipt Checklist.

The results as reported relate only to the item(s) submitted for testing. This report shall be used or copied only in its entirety. Energy Laboratories, Inc. is not responsible for the consequences arising from the use of a partial report.

If you have any questions regarding these test results, please contact your Project Manager.

Report Approved By:



CLIENT: Pioneer Technical Services
Project: BPSOU School Sampling
Work Order: B21081152

Report Date: 08/20/21

CASE NARRATIVE

Tests associated with analyst identified as ELI-H were subcontracted to Energy Laboratories, 3161 East Lyndale Ave, Helena, MT, EPA Number MT00945.



LABORATORY ANALYTICAL REPORT

Prepared by Billings, MT Branch

Client: Pioneer Technical Services
Project: BPSOU School Sampling
Lab ID: B21081152-001
Client Sample ID: BPSOU-KAW-1

Report Date: 08/20/21
Collection Date: 08/10/21 12:30
Date Received: 08/12/21
Matrix: Soil

Analyses	Result	Units	Qualifiers	RL	MCL/ QCL	Method	Analysis Date / By
PHYSICAL CHARACTERISTICS							
Sand	52	%		1		ASA15-5	08/19/21 12:17 / eli-h
Silt	28	%		1		ASA15-5	08/19/21 12:17 / eli-h
Clay	20	%		1		ASA15-5	08/19/21 12:17 / eli-h
Texture	L			1		ASA15-5	08/19/21 12:17 / eli-h
SATURATED PASTE EXTRACT							
pH, sat. paste	7.9	s.u.		0.1		ASA10-3	08/19/21 08:57 / eli-h
Conductivity, sat. paste	1.3	mmhos/cm		0.1		ASA10-3	08/19/21 12:46 / eli-h
Saturation	42.7	%		0.1		USDA27a	08/19/21 08:37 / eli-h
Calcium, sat. paste	6.10	meq/L		0.05		SW6010B	08/19/21 23:25 / eli-h
Magnesium, sat. paste	3.16	meq/L		0.08		SW6010B	08/19/21 23:25 / eli-h
Sodium, sat. paste	2.41	meq/L		0.04		SW6010B	08/19/21 23:25 / eli-h
Sodium Adsorption Ratio (SAR)	1.12	unitless		0.01		USDA20b	08/20/21 12:23 / eli-h
CHEMICAL CHARACTERISTICS							
Organic Matter	3.7	%		0.2		ASA29-3	08/20/21 12:20 / eli-h
SIEVE ANALYSIS							
1 in (25 mm), Retained	5.8	wt%-dry		0.1		SSSA 15-2	08/17/21 16:35 / eli-h
No. 10 (2 mm), Retained	13.1	wt%-dry		0.1		SSSA 15-2	08/17/21 16:35 / eli-h
Pan	81.1	wt%-dry		0.1		SSSA 15-2	08/17/21 16:35 / eli-h

Report Definitions: RL - Analyte Reporting Limit
QCL - Quality Control Limit

MCL - Maximum Contaminant Level
ND - Not detected at the Reporting Limit (RL)



LABORATORY ANALYTICAL REPORT

Prepared by Billings, MT Branch

Client: Pioneer Technical Services
Project: BPSOU School Sampling
Lab ID: B21081152-002
Client Sample ID: BPSOU-KAW-2

Report Date: 08/20/21
Collection Date: 08/10/21 12:35
Date Received: 08/12/21
Matrix: Soil

Analyses	Result	Units	Qualifiers	RL	MCL/ QCL	Method	Analysis Date / By
PHYSICAL CHARACTERISTICS							
Sand	44	%		1		ASA15-5	08/19/21 12:17 / eli-h
Silt	32	%		1		ASA15-5	08/19/21 12:17 / eli-h
Clay	24	%		1		ASA15-5	08/19/21 12:17 / eli-h
Texture	L			1		ASA15-5	08/19/21 12:17 / eli-h
SATURATED PASTE EXTRACT							
pH, sat. paste	8.0	s.u.		0.1		ASA10-3	08/19/21 08:57 / eli-h
Conductivity, sat. paste	0.9	mmhos/cm		0.1		ASA10-3	08/19/21 12:47 / eli-h
Saturation	43.7	%		0.1		USDA27a	08/19/21 08:37 / eli-h
Calcium, sat. paste	4.38	meq/L		0.05		SW6010B	08/19/21 23:42 / eli-h
Magnesium, sat. paste	2.60	meq/L		0.08		SW6010B	08/19/21 23:42 / eli-h
Sodium, sat. paste	1.44	meq/L		0.04		SW6010B	08/19/21 23:42 / eli-h
Sodium Adsorption Ratio (SAR)	0.77	unitless		0.01		USDA20b	08/20/21 12:23 / eli-h
CHEMICAL CHARACTERISTICS							
Organic Matter	3.5	%		0.2		ASA29-3	08/20/21 12:20 / eli-h
SIEVE ANALYSIS							
1 in (25 mm), Retained	< 0.1	wt%-dry		0.1		SSSA 15-2	08/17/21 16:35 / eli-h
No. 10 (2 mm), Retained	17.3	wt%-dry		0.1		SSSA 15-2	08/17/21 16:35 / eli-h
Pan	82.7	wt%-dry		0.1		SSSA 15-2	08/17/21 16:35 / eli-h

Report Definitions: RL - Analyte Reporting Limit
QCL - Quality Control Limit

MCL - Maximum Contaminant Level
ND - Not detected at the Reporting Limit (RL)



LABORATORY ANALYTICAL REPORT

Prepared by Billings, MT Branch

Client: Pioneer Technical Services
Project: BPSOU School Sampling
Lab ID: B21081152-003
Client Sample ID: BPSOU-KAW-3

Report Date: 08/20/21
Collection Date: 08/10/21 12:40
Date Received: 08/12/21
Matrix: Soil

Analyses	Result	Units	Qualifiers	RL	MCL/ QCL	Method	Analysis Date / By
PHYSICAL CHARACTERISTICS							
Sand	42	%		1		ASA15-5	08/19/21 12:17 / eli-h
Silt	32	%		1		ASA15-5	08/19/21 12:17 / eli-h
Clay	26	%		1		ASA15-5	08/19/21 12:17 / eli-h
Texture	L			1		ASA15-5	08/19/21 12:17 / eli-h
SATURATED PASTE EXTRACT							
pH, sat. paste	7.8	s.u.		0.1		ASA10-3	08/19/21 08:58 / eli-h
Conductivity, sat. paste	1.5	mmhos/cm		0.1		ASA10-3	08/19/21 12:47 / eli-h
Saturation	44.4	%		0.1		USDA27a	08/19/21 08:38 / eli-h
Calcium, sat. paste	8.57	meq/L		0.05		SW6010B	08/19/21 23:46 / eli-h
Magnesium, sat. paste	3.22	meq/L		0.08		SW6010B	08/19/21 23:46 / eli-h
Sodium, sat. paste	1.90	meq/L		0.04		SW6010B	08/19/21 23:46 / eli-h
Sodium Adsorption Ratio (SAR)	0.78	unitless		0.01		USDA20b	08/20/21 12:23 / eli-h
CHEMICAL CHARACTERISTICS							
Organic Matter	3.6	%		0.2		ASA29-3	08/20/21 12:20 / eli-h
SIEVE ANALYSIS							
1 in (25 mm), Retained	3.6	wt%-dry		0.1		SSSA 15-2	08/17/21 16:35 / eli-h
No. 10 (2 mm), Retained	12.5	wt%-dry		0.1		SSSA 15-2	08/17/21 16:35 / eli-h
Pan	83.9	wt%-dry		0.1		SSSA 15-2	08/17/21 16:35 / eli-h

Report Definitions: RL - Analyte Reporting Limit
QCL - Quality Control Limit

MCL - Maximum Contaminant Level
ND - Not detected at the Reporting Limit (RL)



LABORATORY ANALYTICAL REPORT

Prepared by Billings, MT Branch

Client: Pioneer Technical Services
Project: BPSOU School Sampling
Lab ID: B21081152-004
Client Sample ID: BPSOU-KAW-4

Report Date: 08/20/21
Collection Date: 08/10/21 12:45
Date Received: 08/12/21
Matrix: Soil

Analyses	Result	Units	Qualifiers	RL	MCL/ QCL	Method	Analysis Date / By
PHYSICAL CHARACTERISTICS							
Sand	34	%		1		ASA15-5	08/19/21 12:17 / eli-h
Silt	38	%		1		ASA15-5	08/19/21 12:17 / eli-h
Clay	28	%		1		ASA15-5	08/19/21 12:17 / eli-h
Texture	CL			1		ASA15-5	08/19/21 12:17 / eli-h
SATURATED PASTE EXTRACT							
pH, sat. paste	7.7	s.u.		0.1		ASA10-3	08/19/21 08:59 / eli-h
Conductivity, sat. paste	1.5	mmhos/cm		0.1		ASA10-3	08/19/21 12:48 / eli-h
Saturation	49.4	%		0.1		USDA27a	08/19/21 08:38 / eli-h
Calcium, sat. paste	8.03	meq/L		0.05		SW6010B	08/19/21 23:51 / eli-h
Magnesium, sat. paste	3.97	meq/L		0.08		SW6010B	08/19/21 23:51 / eli-h
Sodium, sat. paste	1.38	meq/L		0.04		SW6010B	08/19/21 23:51 / eli-h
Sodium Adsorption Ratio (SAR)	0.56	unitless		0.01		USDA20b	08/20/21 12:23 / eli-h
CHEMICAL CHARACTERISTICS							
Organic Matter	3.5	%		0.2		ASA29-3	08/20/21 12:20 / eli-h
SIEVE ANALYSIS							
1 in (25 mm), Retained	< 0.1	wt%-dry		0.1		SSSA 15-2	08/17/21 16:35 / eli-h
No. 10 (2 mm), Retained	12.2	wt%-dry		0.1		SSSA 15-2	08/17/21 16:35 / eli-h
Pan	87.8	wt%-dry		0.1		SSSA 15-2	08/17/21 16:35 / eli-h

Report Definitions: RL - Analyte Reporting Limit
QCL - Quality Control Limit

MCL - Maximum Contaminant Level
ND - Not detected at the Reporting Limit (RL)



LABORATORY ANALYTICAL REPORT

Prepared by Billings, MT Branch

Client: Pioneer Technical Services
Project: BPSOU School Sampling
Lab ID: B21081152-005
Client Sample ID: BPSOU-KAW-5

Report Date: 08/20/21
Collection Date: 08/10/21 12:50
Date Received: 08/12/21
Matrix: Soil

Analyses	Result	Units	Qualifiers	RL	MCL/ QCL	Method	Analysis Date / By
PHYSICAL CHARACTERISTICS							
Sand	28	%		1		ASA15-5	08/19/21 12:17 / eli-h
Silt	42	%		1		ASA15-5	08/19/21 12:17 / eli-h
Clay	30	%		1		ASA15-5	08/19/21 12:17 / eli-h
Texture	CL			1		ASA15-5	08/19/21 12:17 / eli-h
SATURATED PASTE EXTRACT							
pH, sat. paste	7.8	s.u.		0.1		ASA10-3	08/19/21 09:00 / eli-h
Conductivity, sat. paste	1.0	mmhos/cm		0.1		ASA10-3	08/19/21 12:49 / eli-h
Saturation	52.2	%		0.1		USDA27a	08/19/21 08:38 / eli-h
Calcium, sat. paste	5.10	meq/L		0.05		SW6010B	08/19/21 23:55 / eli-h
Magnesium, sat. paste	3.13	meq/L		0.08		SW6010B	08/19/21 23:55 / eli-h
Sodium, sat. paste	0.96	meq/L		0.04		SW6010B	08/19/21 23:55 / eli-h
Sodium Adsorption Ratio (SAR)	0.47	unitless		0.01		USDA20b	08/20/21 12:23 / eli-h
CHEMICAL CHARACTERISTICS							
Organic Matter	3.8	%		0.2		ASA29-3	08/20/21 12:20 / eli-h
SIEVE ANALYSIS							
1 in (25 mm), Retained	1.6	wt%-dry		0.1		SSSA 15-2	08/17/21 16:35 / eli-h
No. 10 (2 mm), Retained	9.3	wt%-dry		0.1		SSSA 15-2	08/17/21 16:35 / eli-h
Pan	89.0	wt%-dry		0.1		SSSA 15-2	08/17/21 16:35 / eli-h

Report Definitions: RL - Analyte Reporting Limit
QCL - Quality Control Limit

MCL - Maximum Contaminant Level
ND - Not detected at the Reporting Limit (RL)



LABORATORY ANALYTICAL REPORT

Prepared by Billings, MT Branch

Client: Pioneer Technical Services
Project: BPSOU School Sampling
Lab ID: B21081152-006
Client Sample ID: BPSOU-KAW-6

Report Date: 08/20/21
Collection Date: 08/10/21 12:55
Date Received: 08/12/21
Matrix: Soil

Analyses	Result	Units	Qualifiers	RL	MCL/ QCL	Method	Analysis Date / By
PHYSICAL CHARACTERISTICS							
Sand	34	%		1		ASA15-5	08/19/21 12:17 / eli-h
Silt	40	%		1		ASA15-5	08/19/21 12:17 / eli-h
Clay	26	%		1		ASA15-5	08/19/21 12:17 / eli-h
Texture	L			1		ASA15-5	08/19/21 12:17 / eli-h
SATURATED PASTE EXTRACT							
pH, sat. paste	7.9	s.u.		0.1		ASA10-3	08/19/21 09:02 / eli-h
Conductivity, sat. paste	1.4	mmhos/cm		0.1		ASA10-3	08/19/21 12:50 / eli-h
Saturation	49.2	%		0.1		USDA27a	08/19/21 08:38 / eli-h
Calcium, sat. paste	6.64	meq/L		0.05		SW6010B	08/20/21 00:04 / eli-h
Magnesium, sat. paste	4.32	meq/L		0.08		SW6010B	08/20/21 00:04 / eli-h
Sodium, sat. paste	2.06	meq/L		0.04		SW6010B	08/20/21 00:04 / eli-h
Sodium Adsorption Ratio (SAR)	0.88	unitless		0.01		USDA20b	08/20/21 12:23 / eli-h
CHEMICAL CHARACTERISTICS							
Organic Matter	3.7	%		0.2		ASA29-3	08/20/21 12:20 / eli-h
SIEVE ANALYSIS							
1 in (25 mm), Retained	< 0.1	wt%-dry		0.1		SSSA 15-2	08/17/21 16:35 / eli-h
No. 10 (2 mm), Retained	11.0	wt%-dry		0.1		SSSA 15-2	08/17/21 16:35 / eli-h
Pan	89.0	wt%-dry		0.1		SSSA 15-2	08/17/21 16:35 / eli-h

Report Definitions: RL - Analyte Reporting Limit
QCL - Quality Control Limit

MCL - Maximum Contaminant Level
ND - Not detected at the Reporting Limit (RL)



LABORATORY ANALYTICAL REPORT

Prepared by Billings, MT Branch

Client: Pioneer Technical Services
Project: BPSOU School Sampling
Lab ID: B21081152-007
Client Sample ID: BPSOU-KAW-7

Report Date: 08/20/21
Collection Date: 08/10/21 13:00
DateReceived: 08/12/21
Matrix: Soil

Analyses	Result	Units	Qualifiers	RL	MCL/ QCL	Method	Analysis Date / By
PHYSICAL CHARACTERISTICS							
Sand	32	%		1		ASA15-5	08/19/21 12:17 / eli-h
Silt	40	%		1		ASA15-5	08/19/21 12:17 / eli-h
Clay	28	%		1		ASA15-5	08/19/21 12:17 / eli-h
Texture	CL			1		ASA15-5	08/19/21 12:17 / eli-h
SATURATED PASTE EXTRACT							
pH, sat. paste	7.5	s.u.		0.1		ASA10-3	08/19/21 09:02 / eli-h
Conductivity, sat. paste	1.3	mmhos/cm		0.1		ASA10-3	08/19/21 12:51 / eli-h
Saturation	49.3	%		0.1		USDA27a	08/19/21 08:38 / eli-h
Calcium, sat. paste	7.19	meq/L		0.05		SW6010B	08/20/21 00:51 / eli-h
Magnesium, sat. paste	3.45	meq/L		0.08		SW6010B	08/20/21 00:51 / eli-h
Sodium, sat. paste	0.90	meq/L		0.04		SW6010B	08/20/21 00:51 / eli-h
Sodium Adsorption Ratio (SAR)	0.39	unitless		0.01		USDA20b	08/20/21 12:23 / eli-h
CHEMICAL CHARACTERISTICS							
Organic Matter	4.1	%		0.2		ASA29-3	08/20/21 12:20 / eli-h
SIEVE ANALYSIS							
1 in (25 mm), Retained	< 0.1	wt%-dry		0.1		SSSA 15-2	08/17/21 16:35 / eli-h
No. 10 (2 mm), Retained	11.5	wt%-dry		0.1		SSSA 15-2	08/17/21 16:35 / eli-h
Pan	88.5	wt%-dry		0.1		SSSA 15-2	08/17/21 16:35 / eli-h

Report Definitions: RL - Analyte Reporting Limit
QCL - Quality Control Limit

MCL - Maximum Contaminant Level
ND - Not detected at the Reporting Limit (RL)



LABORATORY ANALYTICAL REPORT

Prepared by Billings, MT Branch

Client: Pioneer Technical Services
Project: BPSOU School Sampling
Lab ID: B21081152-008
Client Sample ID: BPSOU-KAW-8

Report Date: 08/20/21
Collection Date: 08/10/21 13:05
Date Received: 08/12/21
Matrix: Soil

Analyses	Result	Units	Qualifiers	RL	MCL/ QCL	Method	Analysis Date / By
PHYSICAL CHARACTERISTICS							
Sand	46	%		1		ASA15-5	08/19/21 12:17 / eli-h
Silt	28	%		1		ASA15-5	08/19/21 12:17 / eli-h
Clay	26	%		1		ASA15-5	08/19/21 12:17 / eli-h
Texture	L			1		ASA15-5	08/19/21 12:17 / eli-h
SATURATED PASTE EXTRACT							
pH, sat. paste	7.4	s.u.		0.1		ASA10-3	08/19/21 09:03 / eli-h
Conductivity, sat. paste	2.1	mmhos/cm		0.1		ASA10-3	08/19/21 12:52 / eli-h
Saturation	45.7	%		0.1		USDA27a	08/19/21 08:39 / eli-h
Calcium, sat. paste	12.8	meq/L		0.05		SW6010B	08/20/21 00:56 / eli-h
Magnesium, sat. paste	3.82	meq/L		0.08		SW6010B	08/20/21 00:56 / eli-h
Sodium, sat. paste	2.29	meq/L		0.04		SW6010B	08/20/21 00:56 / eli-h
Sodium Adsorption Ratio (SAR)	0.79	unitless		0.01		USDA20b	08/20/21 12:23 / eli-h
CHEMICAL CHARACTERISTICS							
Organic Matter	3.7	%		0.2		ASA29-3	08/20/21 12:20 / eli-h
SIEVE ANALYSIS							
1 in (25 mm), Retained	< 0.1	wt%-dry		0.1		SSSA 15-2	08/17/21 16:35 / eli-h
No. 10 (2 mm), Retained	12.2	wt%-dry		0.1		SSSA 15-2	08/17/21 16:35 / eli-h
Pan	87.8	wt%-dry		0.1		SSSA 15-2	08/17/21 16:35 / eli-h

Report Definitions: RL - Analyte Reporting Limit
QCL - Quality Control Limit

MCL - Maximum Contaminant Level
ND - Not detected at the Reporting Limit (RL)



QA/QC Summary Report

Prepared by Helena, MT Branch

Client: Pioneer Technical Services

Work Order: B21081152

Report Date: 08/20/21

Analyte	Result	Units	RL	%REC	Low Limit	High Limit	RPD	RPDLimit	Qual
Method: ASA10-3							Analytical Run: SOIL EC_210819A		
Lab ID: ICV_1_210818_1	Initial Calibration Verification Standard								08/19/21 12:43
Conductivity, sat. paste	1.51	mmhos/cm	0.10	107	90	110			
Lab ID: CCV_1_210818_1	Continuing Calibration Verification Standard								08/19/21 12:43
Conductivity, sat. paste	5.22	mmhos/cm	0.10	104	90	110			
Lab ID: CCV1_1_210818_1	Continuing Calibration Verification Standard								08/19/21 12:44
Conductivity, sat. paste	0.924	mmhos/cm	0.10	92	90	110			
Method: ASA10-3							Batch: 57600		
Lab ID: MB-57600	Method Blank								08/19/21 12:45
Conductivity, sat. paste	ND	mmhos/cm	0.05						Run: SOIL EC_210819A
Lab ID: LCS-57600	Laboratory Control Sample								08/19/21 12:46
Conductivity, sat. paste	4.37	mmhos/cm	0.10	104	80	120			Run: SOIL EC_210819A
Lab ID: B21081152-005ADUP	Sample Duplicate								08/19/21 12:49
Conductivity, sat. paste	1.08	mmhos/cm	0.10				3.1	20	Run: SOIL EC_210819A
Method: ASA10-3							al Run: SOIL PH METER - ORION A211_210819A		
Lab ID: ICV_1_210818_1	Initial Calibration Verification Standard								08/19/21 08:53
pH, sat. paste	7.03	s.u.	0.10	100	98.6	101.4			
Lab ID: CCV_1_210818_1	Continuing Calibration Verification Standard								08/19/21 08:54
pH, sat. paste	7.04	s.u.	0.10	101	98.6	101.4			
Lab ID: CCV1_1_210818_1	Continuing Calibration Verification Standard								08/19/21 08:55
pH, sat. paste	4.01	s.u.	0.10	100	97.5	102.5			
Method: ASA10-3							Batch: 57600		
Lab ID: LCS-57600	Laboratory Control Sample								08/19/21 08:56
pH, sat. paste	8.08	s.u.	0.10	100	95	105			Run: SOIL PH METER - ORION A2
Lab ID: B21081152-005ADUP	Sample Duplicate								08/19/21 09:01
pH, sat. paste	7.82	s.u.	0.10				0.3	20	Run: SOIL PH METER - ORION A2

Qualifiers:

RL - Analyte Reporting Limit

ND - Not detected at the Reporting Limit (RL)



QA/QC Summary Report

Prepared by Helena, MT Branch

Client: Pioneer Technical Services

Work Order: B21081152

Report Date: 08/20/21

Analyte	Result	Units	RL	%REC	Low Limit	High Limit	RPD	RPDLimit	Qual
---------	--------	-------	----	------	-----------	------------	-----	----------	------

Method: ASA15-5

Batch: 57612

Lab ID:	B21081152-002ADUP	Sample Duplicate					Run: SOIL HYDROMETER_210820	08/19/21 12:17
Sand	44.0	%	1.0				0.0	20
Silt	32.0	%	1.0				0.0	20
Clay	24.0	%	1.0				0.0	20
Texture	L		1.0					

Lab ID:	LCS-57612	Laboratory Control Sample					Run: SOIL HYDROMETER_210820	08/19/21 12:17
Sand	46.0	%	1.0	110	70	130		
Silt	28.0	%	1.0	88	70	130		
Clay	26.0	%	1.0	100	70	130		

Qualifiers:

RL - Analyte Reporting Limit

ND - Not detected at the Reporting Limit (RL)



QA/QC Summary Report

Prepared by Helena, MT Branch

Client: Pioneer Technical Services

Work Order: B21081152

Report Date: 08/20/21

Analyte	Result	Units	RL	%REC	Low Limit	High Limit	RPD	RPDLimit	Qual
Method: ASA29-3									Batch: 57606
Lab ID: LCS-57606	Laboratory Control Sample								Run: MISC SOILS_210820A 08/20/21 12:20
Organic Matter	1.13	%	0.17	116	70	130			
Lab ID: MB-57606	Method Blank								Run: MISC SOILS_210820A 08/20/21 12:20
Organic Matter	ND	%	0.2						
Lab ID: B21081152-006ADUP	Sample Duplicate								Run: MISC SOILS_210820A 08/20/21 12:20
Organic Matter	3.74	%	0.17						

Qualifiers:

RL - Analyte Reporting Limit

ND - Not detected at the Reporting Limit (RL)



QA/QC Summary Report

Prepared by Helena, MT Branch

Client: Pioneer Technical Services

Work Order: B21081152

Report Date: 08/20/21

Analyte	Result	Units	RL	%REC	Low Limit	High Limit	RPD	RPDLimit	Qual	
Method: SW6010B							Analytical Run: ICP2-HE_210819B			
Lab ID: ICV	Initial Calibration Verification Standard							08/19/21 14:52		
Calcium	40.3	mg/L	1.0	101	90	110				
Magnesium	39.9	mg/L	1.0	100	90	110				
Sodium	40.0	mg/L	1.0	100	90	110				
Lab ID: CCV	Continuing Calibration Verification Standard							08/19/21 14:56		
Calcium	25.2	mg/L	1.0	101	90	110				
Magnesium	24.9	mg/L	1.0	100	90	110				
Sodium	25.4	mg/L	1.0	102	90	110				
Lab ID: ICB	Continuing Calibration Blank							08/19/21 15:00		
Calcium	0.0347	mg/L	1.0							
Magnesium	0.0127	mg/L	1.0							
Sodium	0.00124	mg/L	1.0							
Lab ID: ICSA	Interference Check Sample A							08/19/21 15:09		
Calcium	483	mg/L	1.0	97	80	120				
Magnesium	535	mg/L	1.0	107	80	120				
Sodium	-0.00132	mg/L	1.0		0	0				
Lab ID: ICSAB	Interference Check Sample AB							08/19/21 15:14		
Calcium	489	mg/L	1.0	98	80	120				
Magnesium	536	mg/L	1.0	107	80	120				
Sodium	19.6	mg/L	1.0	98	80	120				
Method: SW6010B							Batch: 57600			
Lab ID: MB-57600	Method Blank							Run: ICP2-HE_210819B		08/19/21 23:03
Calcium	ND	mg/L	0.1							
Magnesium	ND	mg/L	0.02							
Sodium	ND	mg/L	0.02							
Calcium, sat. paste	ND	meq/L	0.007							
Magnesium, sat. paste	ND	meq/L	0.002							
Sodium, sat. paste	ND	meq/L	0.0009							
Lab ID: LFB-57600	Laboratory Fortified Blank							Run: ICP2-HE_210819B		08/19/21 23:08
Calcium	48.7	mg/L	1.0	97	80	120				
Magnesium	52.8	mg/L	1.0	106	80	120				
Sodium	52.4	mg/L	1.0	105	80	120				
Calcium, sat. paste	2.43	meq/L	0.050	97	80	120				
Magnesium, sat. paste	4.35	meq/L	0.082	106	80	120				
Sodium, sat. paste	2.28	meq/L	0.043	105	80	120				
Lab ID: LCS-57600	Laboratory Control Sample							Run: ICP2-HE_210819B		08/19/21 23:12
Calcium	209	mg/L	1.0	96	70	130				
Magnesium	80.6	mg/L	1.0	95	70	130				
Sodium	692	mg/L	1.0	113	70	130				

Qualifiers:

RL - Analyte Reporting Limit

ND - Not detected at the Reporting Limit (RL)



QA/QC Summary Report

Prepared by Helena, MT Branch

Client: Pioneer Technical Services

Work Order: B21081152

Report Date: 08/20/21

Analyte	Result	Units	RL	%REC	Low Limit	High Limit	RPD	RPDLimit	Qual
---------	--------	-------	----	------	-----------	------------	-----	----------	------

Method: SW6010B Batch: 57600

Lab ID: LCS-57600 Laboratory Control Sample Run: ICP2-HE_210819B 08/19/21 23:12

Calcium, sat. paste	10.4	meq/L	0.050	96	70	130			
Magnesium, sat. paste	6.64	meq/L	0.082	95	70	130			
Sodium, sat. paste	30.1	meq/L	0.043	113	70	130			

Lab ID: B21081152-001AMS2 Sample Matrix Spike Run: ICP2-HE_210819B 08/19/21 23:34

Calcium	215	mg/L	1.0	92	70	130			
Magnesium	141	mg/L	1.0	102	70	130			
Sodium	162	mg/L	1.0	107	70	130			
Calcium, sat. paste	10.7	meq/L	0.050	92	70	130			
Magnesium, sat. paste	11.6	meq/L	0.082	102	70	130			
Sodium, sat. paste	7.04	meq/L	0.043	107	70	130			

Lab ID: B21081152-001AMSD2 Sample Matrix Spike Duplicate Run: ICP2-HE_210819B 08/19/21 23:38

Calcium	217	mg/L	1.0	95	70	130	1.2	20	
Magnesium	142	mg/L	1.0	104	70	130	0.9	20	
Sodium	157	mg/L	1.0	102	70	130	3.0	20	
Calcium, sat. paste	10.8	meq/L	0.050	95	70	130	1.2	20	
Magnesium, sat. paste	11.7	meq/L	0.082	104	70	130	0.9	20	
Sodium, sat. paste	6.83	meq/L	0.043	102	70	130	3.0	20	

Lab ID: B21081152-005Adup Sample Duplicate Run: ICP2-HE_210819B 08/19/21 23:59

Calcium	104	mg/L	1.0				1.9	30	
Magnesium	38.8	mg/L	1.0				1.9	30	
Sodium	22.9	mg/L	1.0				3.8	30	
Calcium, sat. paste	5.20	meq/L	0.050				1.9	30	
Magnesium, sat. paste	3.19	meq/L	0.082				1.9	30	
Sodium, sat. paste	0.994	meq/L	0.043				3.8	30	

Qualifiers:

RL - Analyte Reporting Limit

ND - Not detected at the Reporting Limit (RL)



QA/QC Summary Report

Prepared by Helena, MT Branch

Client: Pioneer Technical Services

Work Order: B21081152

Report Date: 08/20/21

Analyte	Result	Units	RL	%REC	Low Limit	High Limit	RPD	RPDLimit	Qual
Method: USDA20b							Batch: 57600		
Lab ID: B21081152-005ADUP	Sample Duplicate				Run: SOIL CALC_210820A		08/20/21 12:23		
Sodium Adsorption Ratio (SAR)	0.480	unitless	0.10				2.1	30	
Lab ID: LCS-57600	Laboratory Control Sample				Run: SOIL CALC_210820A		08/20/21 12:23		
Sodium Adsorption Ratio (SAR)	10.3	unitless	0.10	117	80	120			

Qualifiers:

RL - Analyte Reporting Limit

ND - Not detected at the Reporting Limit (RL)



QA/QC Summary Report

Prepared by Helena, MT Branch

Client: Pioneer Technical Services

Work Order: B21081152

Report Date: 08/20/21

Analyte	Result	Units	RL	%REC	Low Limit	High Limit	RPD	RPDLimit	Qual
Method: USDA27a									Batch: 57600
Lab ID: LCS-57600	Laboratory Control Sample								Run: SOIL DRYING OVEN 2_21082 08/19/21 08:37
Saturation	42.0	%	0.10	101	80	120			
Lab ID: B21081152-005ADUP	Sample Duplicate								Run: SOIL DRYING OVEN 2_21082 08/19/21 08:38
Saturation	51.1	%	0.10				2.3	20	

Qualifiers:

RL - Analyte Reporting Limit

ND - Not detected at the Reporting Limit (RL)



Work Order Receipt Checklist

Pioneer Technical Services

B21081152

Login completed by: Richard L. Shular

Date Received: 8/12/2021

Reviewed by: BL2000\tedwards

Received by: its

Reviewed Date: 8/16/2021

Carrier name: FedEx

Shipping container/cooler in good condition?	Yes <input checked="" type="checkbox"/>	No <input type="checkbox"/>	Not Present <input type="checkbox"/>
Custody seals intact on all shipping container(s)/cooler(s)?	Yes <input type="checkbox"/>	No <input type="checkbox"/>	Not Present <input checked="" type="checkbox"/>
Custody seals intact on all sample bottles?	Yes <input type="checkbox"/>	No <input type="checkbox"/>	Not Present <input checked="" type="checkbox"/>
Chain of custody present?	Yes <input checked="" type="checkbox"/>	No <input type="checkbox"/>	
Chain of custody signed when relinquished and received?	Yes <input checked="" type="checkbox"/>	No <input type="checkbox"/>	
Chain of custody agrees with sample labels?	Yes <input checked="" type="checkbox"/>	No <input type="checkbox"/>	
Samples in proper container/bottle?	Yes <input checked="" type="checkbox"/>	No <input type="checkbox"/>	
Sample containers intact?	Yes <input checked="" type="checkbox"/>	No <input type="checkbox"/>	
Sufficient sample volume for indicated test?	Yes <input checked="" type="checkbox"/>	No <input type="checkbox"/>	
All samples received within holding time? (Exclude analyses that are considered field parameters such as pH, DO, Res Cl, Sulfite, Ferrous Iron, etc.)	Yes <input checked="" type="checkbox"/>	No <input type="checkbox"/>	
Temp Blank received in all shipping container(s)/cooler(s)?	Yes <input type="checkbox"/>	No <input checked="" type="checkbox"/>	Not Applicable <input type="checkbox"/>
Container/Temp Blank temperature:	23.0°C No Ice		
Water - VOA vials have zero headspace?	Yes <input type="checkbox"/>	No <input type="checkbox"/>	No VOA vials submitted <input checked="" type="checkbox"/>
Water - pH acceptable upon receipt?	Yes <input type="checkbox"/>	No <input type="checkbox"/>	Not Applicable <input checked="" type="checkbox"/>

Standard Reporting Procedures:

Lab measurement of analytes considered field parameters that require analysis within 15 minutes of sampling such as pH, Dissolved Oxygen and Residual Chlorine, are qualified as being analyzed outside of recommended holding time.

Solid/soil samples are reported on a wet weight basis (as received) unless specifically indicated. If moisture corrected, data units are typically noted as –dry. For agricultural and mining soil parameters/characteristics, all samples are dried and ground prior to sample analysis.

Radiochemical precision results represent a 2-sigma Total Measurement Uncertainty.

Contact and Corrective Action Comments:

Results due 08/20/21 per Gina Mccartney, Energy Laboratories Project Manager.



Laboratory Management Program LaMP Chain of Custody Record

BP Site Node Path: _____
 BP Facility No: _____

Req Due Date (mm/dd/yyyy): _____
 Lab Work Order Number: _____

Rush TAT: XX No

Lab Name:	Energy Laboratories		
Lab Address:	1120 S 27th St, Billings MT 59101		
Lab PM:	Gina McCartney		
Lab Phone:	800-735-4489		
Lab Shipping Acct.:			
Lab Bottle Order No:			
Other Info:			
BP Project Manager (PM):	Mike Mc Anulty	BP Project Manager (PM):	BP
BP PM Phone:	406-723-1822	Contractor:	Pioneer Technical Services
BP PM Email:	mcanulmc@bp.com	Consultant/Contractor Project No:	BPSOU School Sampling
		Address:	307 E Park Suite 421, Anaconda MT, 59711
		Consultant/Contractor PM:	Jesse Schwarzrock
		Phone:	406-697-0949
		Email:	j.schwarzrock@pioneer-technical.com
		Email EDD To:	Jesse Schwarzrock
		Invoice To:	BP
		Contractor:	—X

Lab No.	Sample Description	Date	Time	Requested Analyses										Report Type & QC Level									
				Soil / Solid	Water / Liquid	Air / Vapor	Is this location a well?	Total Number of Containers	Unpreserved	H2SO4	HNO3	HCl	Methanol		Texture USDA	% Course Material (1" and 2mm)	Saturation Percentage	Electrical Conductivity	Sodium Adsorption Ratio	Saturated Paste pH	Organic Matter (Walkley Black)		
BPSOU-KAW-1		08/10/21	12:30	X					X									X	X	X	X	RUSH TURNAROUND	08/11/21
BPSOU-KAW-2		08/10/21	12:35	X					X									X	X	X	X	RUSH TURNAROUND	08/11/21
BPSOU-KAW-3		08/10/21	12:40	X					X									X	X	X	X	RUSH TURNAROUND	08/11/21
BPSOU-KAW-4		08/10/21	12:45	X					X									X	X	X	X	RUSH TURNAROUND	08/11/21
BPSOU-KAW-5		08/10/21	12:50	X					X									X	X	X	X	RUSH TURNAROUND	08/11/21
BPSOU-KAW-6		08/10/21	12:55	X					X									X	X	X	X	RUSH TURNAROUND	08/11/21
BPSOU-KAW-7		08/10/21	13:00	X					X									X	X	X	X	RUSH TURNAROUND	08/11/21
BPSOU-KAW-8		08/10/21	13:05	X					X									X	X	X	X	RUSH TURNAROUND	08/11/21

Sampler's Name:	Kile Denney	
Sampler's Company:	Pioneer Technical Services	
Shipment Method:	Fedex	Ship Date: 8/11/21
Shipment Tracking No:	5228 1538 4741	
Special Instructions:	Relinquished By / Affiliation: <i>BP Billings / PTS</i> Date: <i>8/11/21</i> / Time: <i>1600</i> Accepted By / Affiliation: <i>Jesse Schwarzrock</i>	

ATTACHMENT E-2
PACE ANALYTICAL DATA REPORT

August 19, 2021

Jesse Schwarzrock
Pioneer Technical Services
307 E Park
Suite 421
Anaconda, MT 59711

RE: Project: BPSOU School Sampling
Pace Project No.: 10574177

Dear Jesse Schwarzrock:

Enclosed are the analytical results for sample(s) received by the laboratory on August 12, 2021. The results relate only to the samples included in this report. Results contained within this report conform to the most current version of the TNI standards, BP LaMP Technical Requirements Revision 12.1, and any applicable Quality Assurance Project Plan (QAPP), or Work Plan unless otherwise narrated in the body of this report.

The test results provided in this final report were generated by each of the following laboratories within the Pace Network:

- Pace Analytical Services - Minneapolis

If you have any questions concerning this report, please feel free to contact me.

Sincerely,



Jennifer Anderson
jennifer.anderson@pacelabs.com
(612)607-6436
Project Manager

Enclosures

cc: Cole Dallaserra, Pioneer Technical
Jennifer Norman, Portage Inc.



REPORT OF LABORATORY ANALYSIS

This report shall not be reproduced, except in full,
without the written consent of Pace Analytical Services, LLC.

CERTIFICATIONS

Project: BPSOU School Sampling

Pace Project No.: 10574177

Pace Analytical Services, LLC - Minneapolis MN

1700 Elm Street SE, Minneapolis, MN 55414
1800 Elm Street SE, Minneapolis, MN 55414--Satellite Air Lab

A2LA Certification #: 2926.01*
Alabama Certification #: 40770
Alaska Contaminated Sites Certification #: 17-009*
Alaska DW Certification #: MN00064
Arizona Certification #: AZ0014*
Arkansas DW Certification #: MN00064
Arkansas WW Certification #: 88-0680
California Certification #: 2929
Colorado Certification #: MN00064
Connecticut Certification #: PH-0256
EPA Region 8 Tribal Water Systems+Wyoming DW Certification #: via MN 027-053-137
Florida Certification #: E87605*
Georgia Certification #: 959
Hawaii Certification #: MN00064
Idaho Certification #: MN00064
Illinois Certification #: 200011
Indiana Certification #: C-MN-01
Iowa Certification #: 368
Kansas Certification #: E-10167
Kentucky DW Certification #: 90062
Kentucky WW Certification #: 90062
Louisiana DEQ Certification #: AI-03086*
Louisiana DW Certification #: MN00064
Maine Certification #: MN00064*
Maryland Certification #: 322
Michigan Certification #: 9909
Minnesota Certification #: 027-053-137*
Minnesota Dept of Ag Approval: via MN 027-053-137
Minnesota Petrofund Registration #: 1240*
Mississippi Certification #: MN00064

Missouri Certification #: 10100
Montana Certification #: CERT0092
Nebraska Certification #: NE-OS-18-06
Nevada Certification #: MN00064
New Hampshire Certification #: 2081*
New Jersey Certification #: MN002
New York Certification #: 11647*
North Carolina DW Certification #: 27700
North Carolina WW Certification #: 530
North Dakota Certification #: R-036
Ohio DW Certification #: 41244
Ohio VAP Certification (1700) #: CL101
Ohio VAP Certification (1800) #: CL110*
Oklahoma Certification #: 9507*
Oregon Primary Certification #: MN300001
Oregon Secondary Certification #: MN200001*
Pennsylvania Certification #: 68-00563*
Puerto Rico Certification #: MN00064
South Carolina Certification #: 74003001
Tennessee Certification #: TN02818
Texas Certification #: T104704192*
Utah Certification #: MN00064*
Vermont Certification #: VT-027053137
Virginia Certification #: 460163*
Washington Certification #: C486*
West Virginia DEP Certification #: 382
West Virginia DW Certification #: 9952 C
Wisconsin Certification #: 999407970
Wyoming UST Certification #: via A2LA 2926.01
USDA Permit #: P330-19-00208
Please Note: Applicable air certifications are denoted with an asterisk ().

REPORT OF LABORATORY ANALYSIS

This report shall not be reproduced, except in full,
without the written consent of Pace Analytical Services, LLC.

SAMPLE SUMMARY

Project: BPSOU School Sampling

Pace Project No.: 10574177

Lab ID	Sample ID	Matrix	Date Collected	Date Received
10574177001	BPSOU-KAW-1	Solid	08/10/21 12:30	08/12/21 08:50
10574177002	BPSOU-KAW-1	Solid	08/10/21 12:30	08/12/21 08:50
10574177003	BPSOU-KAW-2	Solid	08/10/21 12:35	08/12/21 08:50
10574177004	BPSOU-KAW-2	Solid	08/10/21 12:35	08/12/21 08:50
10574177005	BPSOU-KAW-3	Solid	08/10/21 12:40	08/12/21 08:50
10574177006	BPSOU-KAW-3	Solid	08/10/21 12:40	08/12/21 08:50
10574177007	BPSOU-KAW-4	Solid	08/10/21 12:45	08/12/21 08:50
10574177008	BPSOU-KAW-4	Solid	08/10/21 12:45	08/12/21 08:50
10574177009	BPSOU-KAW-5	Solid	08/10/21 12:50	08/12/21 08:50
10574177010	BPSOU-KAW-5	Solid	08/10/21 12:50	08/12/21 08:50
10574177011	BPSOU-KAW-6	Solid	08/10/21 12:55	08/12/21 08:50
10574177012	BPSOU-KAW-6	Solid	08/10/21 12:55	08/12/21 08:50
10574177013	BPSOU-KAW-7	Solid	08/10/21 13:00	08/12/21 08:50
10574177014	BPSOU-KAW-7	Solid	08/10/21 13:00	08/12/21 08:50
10574177015	BPSOU-KAW-8	Solid	08/10/21 13:05	08/12/21 08:50
10574177016	BPSOU-KAW-8	Solid	08/10/21 13:05	08/12/21 08:50

REPORT OF LABORATORY ANALYSIS

This report shall not be reproduced, except in full,
without the written consent of Pace Analytical Services, LLC.

SAMPLE ANALYTE COUNT

Project: BPSOU School Sampling

Pace Project No.: 10574177

Lab ID	Sample ID	Method	Analysts	Analytes Reported	Laboratory
10574177001	BPSOU-KAW-1	EPA 6020A	BWB	5	PASI-M
10574177002	BPSOU-KAW-1	EPA 7471B	LMW	1	PASI-M
		ASTM D2974	JDL	1	PASI-M
10574177003	BPSOU-KAW-2	EPA 6020A	BWB	5	PASI-M
10574177004	BPSOU-KAW-2	EPA 7471B	LMW	1	PASI-M
		ASTM D2974	JDL	1	PASI-M
10574177005	BPSOU-KAW-3	EPA 6020A	BWB	5	PASI-M
10574177006	BPSOU-KAW-3	EPA 7471B	LMW	1	PASI-M
		ASTM D2974	JDL	1	PASI-M
10574177007	BPSOU-KAW-4	EPA 6020A	BWB	5	PASI-M
10574177008	BPSOU-KAW-4	EPA 7471B	LMW	1	PASI-M
		ASTM D2974	JDL	1	PASI-M
10574177009	BPSOU-KAW-5	EPA 6020A	BWB	5	PASI-M
10574177010	BPSOU-KAW-5	EPA 7471B	LMW	1	PASI-M
		ASTM D2974	JDL	1	PASI-M
10574177011	BPSOU-KAW-6	EPA 6020A	BWB	5	PASI-M
10574177012	BPSOU-KAW-6	EPA 7471B	LMW	1	PASI-M
		ASTM D2974	JDL	1	PASI-M
10574177013	BPSOU-KAW-7	EPA 6020A	BWB	5	PASI-M
10574177014	BPSOU-KAW-7	EPA 7471B	LMW	1	PASI-M
		ASTM D2974	JDL	1	PASI-M
10574177015	BPSOU-KAW-8	EPA 6020A	BWB	5	PASI-M
10574177016	BPSOU-KAW-8	EPA 7471B	LMW	1	PASI-M
		ASTM D2974	JDL	1	PASI-M

PASI-M = Pace Analytical Services - Minneapolis

REPORT OF LABORATORY ANALYSIS

This report shall not be reproduced, except in full,
without the written consent of Pace Analytical Services, LLC.

PROJECT NARRATIVE

Project: BPSOU School Sampling

Pace Project No.: 10574177

Date: August 19, 2021

Samples analyzed for method 6020 arsenic, cadmium, copper, lead and zinc were analyzed after they were dried and sieved using a number 60 sieve.

REPORT OF LABORATORY ANALYSIS

This report shall not be reproduced, except in full,
without the written consent of Pace Analytical Services, LLC.

PROJECT NARRATIVE

Project: BPSOU School Sampling

Pace Project No.: 10574177

Method: EPA 6020A

Description: 6020A MET ICPMS

Client: BPAR-PIONEER-MT

Date: August 19, 2021

General Information:

8 samples were analyzed for EPA 6020A by Pace Analytical Services Minneapolis. All samples were received in acceptable condition with any exceptions noted below or on the chain-of custody and/or the sample condition upon receipt form (SCUR) attached at the end of this report.

Hold Time:

The samples were analyzed within the method required hold times with any exceptions noted below.

Sample Preparation:

The samples were prepared in accordance with EPA 3050B with any exceptions noted below.

Initial Calibrations (including MS Tune as applicable):

All criteria were within method requirements with any exceptions noted below.

Continuing Calibration:

All criteria were within method requirements with any exceptions noted below.

Internal Standards:

All internal standards were within QC limits with any exceptions noted below.

Method Blank:

All analytes were below the report limit in the method blank, where applicable, with any exceptions noted below.

Laboratory Control Spike:

All laboratory control spike compounds were within QC limits with any exceptions noted below.

Matrix Spikes:

All percent recoveries and relative percent differences (RPDs) were within acceptance criteria with any exceptions noted below.

QC Batch: 764488

A matrix spike and/or matrix spike duplicate (MS/MSD) were performed on the following sample(s): 10574177001

M1: Matrix spike recovery exceeded QC limits. Batch accepted based on laboratory control sample (LCS) recovery.

- MS (Lab ID: 4075058)
- Zinc

Duplicate Sample:

All duplicate sample results were within method acceptance criteria with any exceptions noted below.

Additional Comments:

REPORT OF LABORATORY ANALYSIS

This report shall not be reproduced, except in full,
without the written consent of Pace Analytical Services, LLC.

PROJECT NARRATIVE

Project: BPSOU School Sampling

Pace Project No.: 10574177

Method: EPA 7471B

Description: 7471B Mercury

Client: BPAR-PIONEER-MT

Date: August 19, 2021

General Information:

8 samples were analyzed for EPA 7471B by Pace Analytical Services Minneapolis. All samples were received in acceptable condition with any exceptions noted below or on the chain-of custody and/or the sample condition upon receipt form (SCUR) attached at the end of this report.

Hold Time:

The samples were analyzed within the method required hold times with any exceptions noted below.

Sample Preparation:

The samples were prepared in accordance with EPA 7471B with any exceptions noted below.

Initial Calibrations (including MS Tune as applicable):

All criteria were within method requirements with any exceptions noted below.

Continuing Calibration:

All criteria were within method requirements with any exceptions noted below.

Method Blank:

All analytes were below the report limit in the method blank, where applicable, with any exceptions noted below.

Laboratory Control Spike:

All laboratory control spike compounds were within QC limits with any exceptions noted below.

Matrix Spikes:

All percent recoveries and relative percent differences (RPDs) were within acceptance criteria with any exceptions noted below.

Duplicate Sample:

All duplicate sample results were within method acceptance criteria with any exceptions noted below.

Additional Comments:

This data package has been reviewed for quality and completeness and is approved for release.

REPORT OF LABORATORY ANALYSIS

This report shall not be reproduced, except in full,
without the written consent of Pace Analytical Services, LLC.

ANALYTICAL RESULTS

Project: BPSOU School Sampling

Pace Project No.: 10574177

Sample: BPSOU-KAW-1 **Lab ID: 10574177001** Collected: 08/10/21 12:30 Received: 08/12/21 08:50 Matrix: Solid

Results reported on a "wet-weight" basis

Parameters	Results	Units	PQL	MDL	DF	Prepared	Analyzed	CAS No.	Qual
6020A MET ICPMS		Analytical Method: EPA 6020A Preparation Method: EPA 3050B Pace Analytical Services - Minneapolis							
Arsenic	26.9	mg/kg	0.50	0.11	1	08/19/21 08:25	08/19/21 11:57	7440-38-2	
Cadmium	0.90	mg/kg	0.079	0.031	1	08/19/21 08:25	08/19/21 11:57	7440-43-9	
Copper	66.9	mg/kg	0.99	0.24	1	08/19/21 08:25	08/19/21 11:57	7440-50-8	
Lead	29.4	mg/kg	0.20	0.029	1	08/19/21 08:25	08/19/21 11:57	7439-92-1	
Zinc	132	mg/kg	5.0	0.89	1	08/19/21 08:25	08/19/21 11:57	7440-66-6	M1

REPORT OF LABORATORY ANALYSIS

This report shall not be reproduced, except in full,
without the written consent of Pace Analytical Services, LLC.

ANALYTICAL RESULTS

Project: BPSOU School Sampling

Pace Project No.: 10574177

Sample: BPSOU-KAW-1 **Lab ID: 10574177002** Collected: 08/10/21 12:30 Received: 08/12/21 08:50 Matrix: Solid

Results reported on a "dry weight" basis and are adjusted for percent moisture, sample size and any dilutions.

Parameters	Results	Units	PQL	MDL	DF	Prepared	Analyzed	CAS No.	Qual
7471B Mercury	Analytical Method: EPA 7471B Preparation Method: EPA 7471B Pace Analytical Services - Minneapolis								
Mercury	0.026	mg/kg	0.022	0.0094	1	08/16/21 13:44	08/18/21 15:47	7439-97-6	
Dry Weight / %M by ASTM D2974	Analytical Method: ASTM D2974 Pace Analytical Services - Minneapolis								
Percent Moisture	10.5	%	0.10	0.10	1		08/17/21 10:41		N2

REPORT OF LABORATORY ANALYSIS

This report shall not be reproduced, except in full,
without the written consent of Pace Analytical Services, LLC.

ANALYTICAL RESULTS

Project: BPSOU School Sampling

Pace Project No.: 10574177

Sample: BPSOU-KAW-2 **Lab ID: 10574177003** Collected: 08/10/21 12:35 Received: 08/12/21 08:50 Matrix: Solid

Results reported on a "wet-weight" basis

Parameters	Results	Units	PQL	MDL	DF	Prepared	Analyzed	CAS No.	Qual
6020A MET ICPMS									
Analytical Method: EPA 6020A Preparation Method: EPA 3050B									
Pace Analytical Services - Minneapolis									
Arsenic	15.9	mg/kg	0.46	0.10	1	08/19/21 08:25	08/19/21 12:17	7440-38-2	
Cadmium	0.49	mg/kg	0.074	0.029	1	08/19/21 08:25	08/19/21 12:17	7440-43-9	
Copper	36.2	mg/kg	0.93	0.22	1	08/19/21 08:25	08/19/21 12:17	7440-50-8	
Lead	16.0	mg/kg	0.19	0.027	1	08/19/21 08:25	08/19/21 12:17	7439-92-1	
Zinc	76.0	mg/kg	4.6	0.83	1	08/19/21 08:25	08/19/21 12:17	7440-66-6	

REPORT OF LABORATORY ANALYSIS

This report shall not be reproduced, except in full,
without the written consent of Pace Analytical Services, LLC.

ANALYTICAL RESULTS

Project: BPSOU School Sampling

Pace Project No.: 10574177

Sample: BPSOU-KAW-2 **Lab ID: 10574177004** Collected: 08/10/21 12:35 Received: 08/12/21 08:50 Matrix: Solid

Results reported on a "dry weight" basis and are adjusted for percent moisture, sample size and any dilutions.

Parameters	Results	Units	PQL	MDL	DF	Prepared	Analyzed	CAS No.	Qual
7471B Mercury	Analytical Method: EPA 7471B Preparation Method: EPA 7471B Pace Analytical Services - Minneapolis								
Mercury	0.022	mg/kg	0.022	0.0095	1	08/16/21 13:44	08/18/21 15:53	7439-97-6	
Dry Weight / %M by ASTM D2974	Analytical Method: ASTM D2974 Pace Analytical Services - Minneapolis								
Percent Moisture	11.7	%	0.10	0.10	1		08/17/21 10:41		N2

REPORT OF LABORATORY ANALYSIS

This report shall not be reproduced, except in full,
without the written consent of Pace Analytical Services, LLC.

ANALYTICAL RESULTS

Project: BPSOU School Sampling

Pace Project No.: 10574177

Sample: BPSOU-KAW-3 **Lab ID: 10574177005** Collected: 08/10/21 12:40 Received: 08/12/21 08:50 Matrix: Solid

Results reported on a "wet-weight" basis

Parameters	Results	Units	PQL	MDL	DF	Prepared	Analyzed	CAS No.	Qual
6020A MET ICPMS									
Analytical Method: EPA 6020A Preparation Method: EPA 3050B									
Pace Analytical Services - Minneapolis									
Arsenic	29.8	mg/kg	0.49	0.11	1	08/19/21 08:25	08/19/21 12:20	7440-38-2	
Cadmium	0.82	mg/kg	0.078	0.031	1	08/19/21 08:25	08/19/21 12:20	7440-43-9	
Copper	64.7	mg/kg	0.98	0.24	1	08/19/21 08:25	08/19/21 12:20	7440-50-8	
Lead	23.8	mg/kg	0.20	0.029	1	08/19/21 08:25	08/19/21 12:20	7439-92-1	
Zinc	103	mg/kg	4.9	0.88	1	08/19/21 08:25	08/19/21 12:20	7440-66-6	

REPORT OF LABORATORY ANALYSIS

This report shall not be reproduced, except in full,
without the written consent of Pace Analytical Services, LLC.

ANALYTICAL RESULTS

Project: BPSOU School Sampling

Pace Project No.: 10574177

Sample: BPSOU-KAW-3 **Lab ID: 10574177006** Collected: 08/10/21 12:40 Received: 08/12/21 08:50 Matrix: Solid

Results reported on a "dry weight" basis and are adjusted for percent moisture, sample size and any dilutions.

Parameters	Results	Units	PQL	MDL	DF	Prepared	Analyzed	CAS No.	Qual
7471B Mercury	Analytical Method: EPA 7471B Preparation Method: EPA 7471B Pace Analytical Services - Minneapolis								
Mercury	0.016J	mg/kg	0.020	0.0086	1	08/16/21 13:44	08/18/21 15:55	7439-97-6	
Dry Weight / %M by ASTM D2974	Analytical Method: ASTM D2974 Pace Analytical Services - Minneapolis								
Percent Moisture	10.9	%	0.10	0.10	1		08/17/21 10:41		N2

REPORT OF LABORATORY ANALYSIS

This report shall not be reproduced, except in full,
without the written consent of Pace Analytical Services, LLC.

ANALYTICAL RESULTS

Project: BPSOU School Sampling

Pace Project No.: 10574177

Sample: BPSOU-KAW-4 **Lab ID: 10574177007** Collected: 08/10/21 12:45 Received: 08/12/21 08:50 Matrix: Solid

Results reported on a "wet-weight" basis

Parameters	Results	Units	PQL	MDL	DF	Prepared	Analyzed	CAS No.	Qual
6020A MET ICPMS									
Analytical Method: EPA 6020A Preparation Method: EPA 3050B									
Pace Analytical Services - Minneapolis									
Arsenic	31.0	mg/kg	0.45	0.099	1	08/19/21 08:25	08/19/21 12:31	7440-38-2	
Cadmium	0.77	mg/kg	0.073	0.029	1	08/19/21 08:25	08/19/21 12:31	7440-43-9	
Copper	77.9	mg/kg	0.91	0.22	1	08/19/21 08:25	08/19/21 12:31	7440-50-8	
Lead	26.6	mg/kg	0.18	0.027	1	08/19/21 08:25	08/19/21 12:31	7439-92-1	
Zinc	129	mg/kg	4.5	0.82	1	08/19/21 08:25	08/19/21 12:31	7440-66-6	

REPORT OF LABORATORY ANALYSIS

This report shall not be reproduced, except in full,
without the written consent of Pace Analytical Services, LLC.

ANALYTICAL RESULTS

Project: BPSOU School Sampling

Pace Project No.: 10574177

Sample: BPSOU-KAW-4 **Lab ID: 10574177008** Collected: 08/10/21 12:45 Received: 08/12/21 08:50 Matrix: Solid

Results reported on a "dry weight" basis and are adjusted for percent moisture, sample size and any dilutions.

Parameters	Results	Units	PQL	MDL	DF	Prepared	Analyzed	CAS No.	Qual
7471B Mercury	Analytical Method: EPA 7471B Preparation Method: EPA 7471B Pace Analytical Services - Minneapolis								
Mercury	0.027	mg/kg	0.019	0.0082	1	08/16/21 13:44	08/18/21 16:00	7439-97-6	
Dry Weight / %M by ASTM D2974	Analytical Method: ASTM D2974 Pace Analytical Services - Minneapolis								
Percent Moisture	9.4	%	0.10	0.10	1		08/17/21 10:41		N2

REPORT OF LABORATORY ANALYSIS

This report shall not be reproduced, except in full,
without the written consent of Pace Analytical Services, LLC.

ANALYTICAL RESULTS

Project: BPSOU School Sampling

Pace Project No.: 10574177

Sample: BPSOU-KAW-5 **Lab ID: 10574177009** Collected: 08/10/21 12:50 Received: 08/12/21 08:50 Matrix: Solid

Results reported on a "wet-weight" basis

Parameters	Results	Units	PQL	MDL	DF	Prepared	Analyzed	CAS No.	Qual
6020A MET ICPMS		Analytical Method: EPA 6020A Preparation Method: EPA 3050B Pace Analytical Services - Minneapolis							
Arsenic	33.9	mg/kg	0.47	0.10	1	08/19/21 08:25	08/19/21 12:34	7440-38-2	
Cadmium	0.90	mg/kg	0.075	0.030	1	08/19/21 08:25	08/19/21 12:34	7440-43-9	
Copper	78.2	mg/kg	0.94	0.23	1	08/19/21 08:25	08/19/21 12:34	7440-50-8	
Lead	26.9	mg/kg	0.19	0.028	1	08/19/21 08:25	08/19/21 12:34	7439-92-1	
Zinc	127	mg/kg	4.7	0.85	1	08/19/21 08:25	08/19/21 12:34	7440-66-6	

REPORT OF LABORATORY ANALYSIS

This report shall not be reproduced, except in full,
without the written consent of Pace Analytical Services, LLC.

ANALYTICAL RESULTS

Project: BPSOU School Sampling

Pace Project No.: 10574177

Sample: BPSOU-KAW-5 **Lab ID: 10574177010** Collected: 08/10/21 12:50 Received: 08/12/21 08:50 Matrix: Solid

Results reported on a "dry weight" basis and are adjusted for percent moisture, sample size and any dilutions.

Parameters	Results	Units	PQL	MDL	DF	Prepared	Analyzed	CAS No.	Qual
7471B Mercury	Analytical Method: EPA 7471B Preparation Method: EPA 7471B Pace Analytical Services - Minneapolis								
Mercury	0.026	mg/kg	0.022	0.0097	1	08/16/21 13:44	08/18/21 16:02	7439-97-6	
Dry Weight / %M by ASTM D2974	Analytical Method: ASTM D2974 Pace Analytical Services - Minneapolis								
Percent Moisture	13.3	%	0.10	0.10	1		08/17/21 10:41		N2

REPORT OF LABORATORY ANALYSIS

This report shall not be reproduced, except in full,
without the written consent of Pace Analytical Services, LLC.

ANALYTICAL RESULTS

Project: BPSOU School Sampling

Pace Project No.: 10574177

Sample: BPSOU-KAW-6 **Lab ID: 10574177011** Collected: 08/10/21 12:55 Received: 08/12/21 08:50 Matrix: Solid

Results reported on a "wet-weight" basis

Parameters	Results	Units	PQL	MDL	DF	Prepared	Analyzed	CAS No.	Qual
6020A MET ICPMS									
Analytical Method: EPA 6020A Preparation Method: EPA 3050B									
Pace Analytical Services - Minneapolis									
Arsenic	43.4	mg/kg	0.47	0.10	1	08/19/21 08:25	08/19/21 12:37	7440-38-2	
Cadmium	1.0	mg/kg	0.075	0.030	1	08/19/21 08:25	08/19/21 12:37	7440-43-9	
Copper	99.3	mg/kg	0.94	0.23	1	08/19/21 08:25	08/19/21 12:37	7440-50-8	
Lead	36.1	mg/kg	0.19	0.028	1	08/19/21 08:25	08/19/21 12:37	7439-92-1	
Zinc	143	mg/kg	4.7	0.85	1	08/19/21 08:25	08/19/21 12:37	7440-66-6	

REPORT OF LABORATORY ANALYSIS

This report shall not be reproduced, except in full,
without the written consent of Pace Analytical Services, LLC.

ANALYTICAL RESULTS

Project: BPSOU School Sampling

Pace Project No.: 10574177

Sample: BPSOU-KAW-6 **Lab ID: 10574177012** Collected: 08/10/21 12:55 Received: 08/12/21 08:50 Matrix: Solid

Results reported on a "dry weight" basis and are adjusted for percent moisture, sample size and any dilutions.

Parameters	Results	Units	PQL	MDL	DF	Prepared	Analyzed	CAS No.	Qual
7471B Mercury	Analytical Method: EPA 7471B Preparation Method: EPA 7471B Pace Analytical Services - Minneapolis								
Mercury	0.027	mg/kg	0.020	0.0088	1	08/16/21 13:44	08/18/21 16:03	7439-97-6	
Dry Weight / %M by ASTM D2974	Analytical Method: ASTM D2974 Pace Analytical Services - Minneapolis								
Percent Moisture	7.2	%	0.10	0.10	1		08/17/21 10:42		N2

REPORT OF LABORATORY ANALYSIS

This report shall not be reproduced, except in full,
without the written consent of Pace Analytical Services, LLC.

ANALYTICAL RESULTS

Project: BPSOU School Sampling

Pace Project No.: 10574177

Sample: BPSOU-KAW-7 **Lab ID: 10574177013** Collected: 08/10/21 13:00 Received: 08/12/21 08:50 Matrix: Solid

Results reported on a "wet-weight" basis

Parameters	Results	Units	PQL	MDL	DF	Prepared	Analyzed	CAS No.	Qual
6020A MET ICPMS									
Analytical Method: EPA 6020A Preparation Method: EPA 3050B									
Pace Analytical Services - Minneapolis									
Arsenic	36.6	mg/kg	0.47	0.10	1	08/19/21 08:25	08/19/21 12:41	7440-38-2	
Cadmium	0.91	mg/kg	0.075	0.030	1	08/19/21 08:25	08/19/21 12:41	7440-43-9	
Copper	85.7	mg/kg	0.94	0.23	1	08/19/21 08:25	08/19/21 12:41	7440-50-8	
Lead	28.8	mg/kg	0.19	0.028	1	08/19/21 08:25	08/19/21 12:41	7439-92-1	
Zinc	133	mg/kg	4.7	0.85	1	08/19/21 08:25	08/19/21 12:41	7440-66-6	

REPORT OF LABORATORY ANALYSIS

This report shall not be reproduced, except in full,
without the written consent of Pace Analytical Services, LLC.

ANALYTICAL RESULTS

Project: BPSOU School Sampling

Pace Project No.: 10574177

Sample: BPSOU-KAW-7 **Lab ID: 10574177014** Collected: 08/10/21 13:00 Received: 08/12/21 08:50 Matrix: Solid

Results reported on a "dry weight" basis and are adjusted for percent moisture, sample size and any dilutions.

Parameters	Results	Units	PQL	MDL	DF	Prepared	Analyzed	CAS No.	Qual
7471B Mercury	Analytical Method: EPA 7471B Preparation Method: EPA 7471B Pace Analytical Services - Minneapolis								
Mercury	0.032	mg/kg	0.018	0.0079	1	08/16/21 13:44	08/18/21 16:05	7439-97-6	
Dry Weight / %M by ASTM D2974	Analytical Method: ASTM D2974 Pace Analytical Services - Minneapolis								
Percent Moisture	8.4	%	0.10	0.10	1		08/17/21 10:42		N2

REPORT OF LABORATORY ANALYSIS

This report shall not be reproduced, except in full,
without the written consent of Pace Analytical Services, LLC.

ANALYTICAL RESULTS

Project: BPSOU School Sampling

Pace Project No.: 10574177

Sample: BPSOU-KAW-8 **Lab ID: 10574177015** Collected: 08/10/21 13:05 Received: 08/12/21 08:50 Matrix: Solid

Results reported on a "wet-weight" basis

Parameters	Results	Units	PQL	MDL	DF	Prepared	Analyzed	CAS No.	Qual
6020A MET ICPMS									
Analytical Method: EPA 6020A Preparation Method: EPA 3050B									
Pace Analytical Services - Minneapolis									
Arsenic	37.8	mg/kg	0.50	0.11	1	08/19/21 08:25	08/19/21 12:44	7440-38-2	
Cadmium	0.86	mg/kg	0.080	0.031	1	08/19/21 08:25	08/19/21 12:44	7440-43-9	
Copper	82.9	mg/kg	1.0	0.24	1	08/19/21 08:25	08/19/21 12:44	7440-50-8	
Lead	27.5	mg/kg	0.20	0.029	1	08/19/21 08:25	08/19/21 12:44	7439-92-1	
Zinc	131	mg/kg	5.0	0.90	1	08/19/21 08:25	08/19/21 12:44	7440-66-6	

REPORT OF LABORATORY ANALYSIS

This report shall not be reproduced, except in full,
without the written consent of Pace Analytical Services, LLC.

ANALYTICAL RESULTS

Project: BPSOU School Sampling

Pace Project No.: 10574177

Sample: BPSOU-KAW-8 **Lab ID: 10574177016** Collected: 08/10/21 13:05 Received: 08/12/21 08:50 Matrix: Solid

Results reported on a "dry weight" basis and are adjusted for percent moisture, sample size and any dilutions.

Parameters	Results	Units	PQL	MDL	DF	Prepared	Analyzed	CAS No.	Qual
7471B Mercury	Analytical Method: EPA 7471B Preparation Method: EPA 7471B Pace Analytical Services - Minneapolis								
Mercury	0.028	mg/kg	0.020	0.0086	1	08/16/21 13:44	08/18/21 16:06	7439-97-6	
Dry Weight / %M by ASTM D2974	Analytical Method: ASTM D2974 Pace Analytical Services - Minneapolis								
Percent Moisture	8.6	%	0.10	0.10	1		08/17/21 10:42		N2

REPORT OF LABORATORY ANALYSIS

This report shall not be reproduced, except in full,
without the written consent of Pace Analytical Services, LLC.

QUALITY CONTROL DATA

Project: BPSOU School Sampling

Pace Project No.: 10574177

QC Batch: 763252

Analysis Method: EPA 7471B

QC Batch Method: EPA 7471B

Analysis Description: 7471B Mercury Solids

Laboratory: Pace Analytical Services - Minneapolis

Associated Lab Samples: 10574177002, 10574177004, 10574177006, 10574177008, 10574177010, 10574177012, 10574177014, 10574177016

METHOD BLANK: 4069399

Matrix: Solid

Associated Lab Samples: 10574177002, 10574177004, 10574177006, 10574177008, 10574177010, 10574177012, 10574177014, 10574177016

Parameter	Units	Blank Result	Reporting Limit	MDL	Analyzed	Qualifiers
Mercury	mg/kg	<0.0087	0.020	0.0087	08/18/21 15:44	

LABORATORY CONTROL SAMPLE: 4069400

Parameter	Units	Spike Conc.	LCS Result	LCS % Rec	% Rec Limits	Qualifiers
Mercury	mg/kg	0.48	0.47	97	80-120	

MATRIX SPIKE & MATRIX SPIKE DUPLICATE: 4069402 4069403

Parameter	Units	10574177002		4069403		MS % Rec	MSD % Rec	% Rec Limits	RPD	Max RPD	Qual
		Result	MS Spike Conc.	MSD Spike Conc.	MS Result						
Mercury	mg/kg	0.026	0.5	0.53	0.50	0.53	93	95	80-120	5	20

SAMPLE DUPLICATE: 4069401

Parameter	Units	10574177002 Result	Dup Result	RPD	Max RPD	Qualifiers
Mercury	mg/kg	0.026	0.028	8	20	

Results presented on this page are in the units indicated by the "Units" column except where an alternate unit is presented to the right of the result.

REPORT OF LABORATORY ANALYSIS

This report shall not be reproduced, except in full,
without the written consent of Pace Analytical Services, LLC.

QUALITY CONTROL DATA

Project: BPSOU School Sampling

Pace Project No.: 10574177

QC Batch:	764488	Analysis Method:	EPA 6020A
QC Batch Method:	EPA 3050B	Analysis Description:	6020A Solids UPD4
		Laboratory:	Pace Analytical Services - Minneapolis

Associated Lab Samples: 10574177001, 10574177003, 10574177005, 10574177007, 10574177009, 10574177011, 10574177013, 10574177015

METHOD BLANK: 4075056 Matrix: Solid
Associated Lab Samples: 10574177001, 10574177003, 10574177005, 10574177007, 10574177009, 10574177011, 10574177013, 10574177015

Parameter	Units	Blank Result	Reporting Limit	MDL	Analyzed	Qualifiers
Arsenic	mg/kg	<0.11	0.50	0.11	08/19/21 11:50	
Cadmium	mg/kg	<0.031	0.079	0.031	08/19/21 11:50	
Copper	mg/kg	<0.24	0.99	0.24	08/19/21 11:50	
Lead	mg/kg	<0.029	0.20	0.029	08/19/21 11:50	
Zinc	mg/kg	<0.89	5.0	0.89	08/19/21 11:50	

LABORATORY CONTROL SAMPLE: 4075057

Parameter	Units	Spike Conc.	LCS Result	LCS % Rec	% Rec Limits	Qualifiers
Arsenic	mg/kg	48.1	54.5	113	80-120	
Cadmium	mg/kg	48.1	56.5	118	80-120	
Copper	mg/kg	48.1	57.1	119	80-120	
Lead	mg/kg	48.1	56.3	117	80-120	
Zinc	mg/kg	48.1	55.9	116	80-120	

MATRIX SPIKE & MATRIX SPIKE DUPLICATE: 4075058 4075059

Parameter	Units	MS		MSD		MS		MSD		% Rec Limits	RPD	Max RPD	Qual
		10574177001	Spike Conc.	Spike Conc.	Result	Result	% Rec	% Rec					
Arsenic	mg/kg	26.9	48.1	47.6	82.6	82.6	116	117	75-125	0	20		
Cadmium	mg/kg	0.90	48.1	47.6	58.1	57.4	119	119	75-125	1	20		
Copper	mg/kg	66.9	48.1	47.6	127	124	125	119	75-125	3	20		
Lead	mg/kg	29.4	48.1	47.6	85.6	85.6	117	118	75-125	0	20		
Zinc	mg/kg	132	48.1	47.6	194	191	130	123	75-125	2	20 M1		

SAMPLE DUPLICATE: 4075963

Parameter	Units	10574177001 Result	Dup Result	RPD	Max RPD	Qualifiers
Arsenic	mg/kg	26.9	27.3	2	20	
Cadmium	mg/kg	0.90	0.94	5	20	
Copper	mg/kg	66.9	68.1	2	20	
Lead	mg/kg	29.4	30.0	2	20	
Zinc	mg/kg	132	133	1	20	

Results presented on this page are in the units indicated by the "Units" column except where an alternate unit is presented to the right of the result.

REPORT OF LABORATORY ANALYSIS

This report shall not be reproduced, except in full,
without the written consent of Pace Analytical Services, LLC.

QUALITY CONTROL DATA

Project: BPSOU School Sampling

Pace Project No.: 10574177

QC Batch: 763834

Analysis Method: ASTM D2974

QC Batch Method: ASTM D2974

Analysis Description: Dry Weight / %M by ASTM D2974

Laboratory: Pace Analytical Services - Minneapolis

Associated Lab Samples: 10574177002, 10574177004, 10574177006, 10574177008, 10574177010, 10574177012, 10574177014, 10574177016

SAMPLE DUPLICATE: 4072583

Parameter	Units	10573913001 Result	Dup Result	RPD	Max RPD	Qualifiers
Percent Moisture	%	6.6	6.3	5	30	N2

SAMPLE DUPLICATE: 4072770

Parameter	Units	10574177014 Result	Dup Result	RPD	Max RPD	Qualifiers
Percent Moisture	%	8.4	7.9	6	30	N2

Results presented on this page are in the units indicated by the "Units" column except where an alternate unit is presented to the right of the result.

REPORT OF LABORATORY ANALYSIS

This report shall not be reproduced, except in full,
without the written consent of Pace Analytical Services, LLC.

QUALIFIERS

Project: BPSOU School Sampling

Pace Project No.: 10574177

DEFINITIONS

DF - Dilution Factor, if reported, represents the factor applied to the reported data due to dilution of the sample aliquot.

ND - Not Detected at or above adjusted reporting limit.

TNTC - Too Numerous To Count

J - Estimated concentration above the adjusted method detection limit and below the adjusted reporting limit.

MDL - Adjusted Method Detection Limit.

PQL - Practical Quantitation Limit.

RL - Reporting Limit - The lowest concentration value that meets project requirements for quantitative data with known precision and bias for a specific analyte in a specific matrix.

S - Surrogate

1,2-Diphenylhydrazine decomposes to and cannot be separated from Azobenzene using Method 8270. The result for each analyte is a combined concentration.

Consistent with EPA guidelines, unrounded data are displayed and have been used to calculate % recovery and RPD values.

LCS(D) - Laboratory Control Sample (Duplicate)

MS(D) - Matrix Spike (Duplicate)

DUP - Sample Duplicate

RPD - Relative Percent Difference

NC - Not Calculable.

SG - Silica Gel - Clean-Up

U - Indicates the compound was analyzed for, but not detected.

N-Nitrosodiphenylamine decomposes and cannot be separated from Diphenylamine using Method 8270. The result reported for each analyte is a combined concentration.

Pace Analytical is TNI accredited. Contact your Pace PM for the current list of accredited analytes.

TNI - The NELAC Institute.

ANALYTE QUALIFIERS

M1 Matrix spike recovery exceeded QC limits. Batch accepted based on laboratory control sample (LCS) recovery.

N2 The lab does not hold NELAC/TNI accreditation for this parameter but other accreditations/certifications may apply. A complete list of accreditations/certifications is available upon request.

REPORT OF LABORATORY ANALYSIS

This report shall not be reproduced, except in full,
without the written consent of Pace Analytical Services, LLC.

QUALITY CONTROL DATA CROSS REFERENCE TABLE

Project: BPSOU School Sampling

Pace Project No.: 10574177

Lab ID	Sample ID	QC Batch Method	QC Batch	Analytical Method	Analytical Batch
10574177001	BPSOU-KAW-1	EPA 3050B	764488	EPA 6020A	764645
10574177003	BPSOU-KAW-2	EPA 3050B	764488	EPA 6020A	764645
10574177005	BPSOU-KAW-3	EPA 3050B	764488	EPA 6020A	764645
10574177007	BPSOU-KAW-4	EPA 3050B	764488	EPA 6020A	764645
10574177009	BPSOU-KAW-5	EPA 3050B	764488	EPA 6020A	764645
10574177011	BPSOU-KAW-6	EPA 3050B	764488	EPA 6020A	764645
10574177013	BPSOU-KAW-7	EPA 3050B	764488	EPA 6020A	764645
10574177015	BPSOU-KAW-8	EPA 3050B	764488	EPA 6020A	764645
10574177002	BPSOU-KAW-1	EPA 7471B	763252	EPA 7471B	764049
10574177004	BPSOU-KAW-2	EPA 7471B	763252	EPA 7471B	764049
10574177006	BPSOU-KAW-3	EPA 7471B	763252	EPA 7471B	764049
10574177008	BPSOU-KAW-4	EPA 7471B	763252	EPA 7471B	764049
10574177010	BPSOU-KAW-5	EPA 7471B	763252	EPA 7471B	764049
10574177012	BPSOU-KAW-6	EPA 7471B	763252	EPA 7471B	764049
10574177014	BPSOU-KAW-7	EPA 7471B	763252	EPA 7471B	764049
10574177016	BPSOU-KAW-8	EPA 7471B	763252	EPA 7471B	764049
10574177002	BPSOU-KAW-1	ASTM D2974	763834		
10574177004	BPSOU-KAW-2	ASTM D2974	763834		
10574177006	BPSOU-KAW-3	ASTM D2974	763834		
10574177008	BPSOU-KAW-4	ASTM D2974	763834		
10574177010	BPSOU-KAW-5	ASTM D2974	763834		
10574177012	BPSOU-KAW-6	ASTM D2974	763834		
10574177014	BPSOU-KAW-7	ASTM D2974	763834		
10574177016	BPSOU-KAW-8	ASTM D2974	763834		

REPORT OF LABORATORY ANALYSIS

This report shall not be reproduced, except in full,
without the written consent of Pace Analytical Services, LLC.



Laboratory Management Program LAMP Chain of Custody Record

Brown #4

Req Due Date (mm/dd/yy):
Lab Work Order Number:

BP Site Node Path:
BP Facility No:

Lab Name:	Pace Analytical Services	Facility Address:	Pioneer Technical Services
Lab Address:	1700 Elm Street Minneapolis, MN 55414	City, State, ZIP Code:	BPSOU School Sampling
Lab PM:	Jennifer Anderson	Lead Regulatory Agency:	307 E Park Suite 421, Anaconda MT, 59711
Lab Phone:	612-607-1700	California Global ID No.:	Jesse Schwarzrock
Lab Shipping Acct:		Enfos Proposal No.:	Phone: 406-697-0949 Email: jschwarzrock@pioneer-technical.com
Lab Bottle Order No.:		Accounting Mode:	Provision
Other Info:		Stage:	Activity:

BP Project Manager (PM):	Mike Mc Anulty	Requested Analyses:	Report Type & QC Level
BP PM Phone:	406-723-1822	<div style="text-align: center;"> <p>WO# : 10574177</p> <p>10574177</p> </div>	Standard x
BP PM E-mail:	mcanumc@bp.com		Full Data Package

Lab No.	Sample Description	Date	Time	Matrix					No. Containers / Preservative				Requested Analyses		Report Type & QC Level	
				Soil / Solid	Water / Liquid	Air / Vapor	Is this location a well?	Total Number of Containers	Unpreserved	H2SO4	HNO3	HCl	Methanol	Al dry&slvle*, 6020 (As, Cd, Cu, Pb, Zn)		7471 Mercury, dry weight
BPSOU-KAW-1		08/10/21	12:30	X				2					X	X	RUSH TURNAROUND	001
BPSOU-KAW-2		08/10/21	12:35	X				2					X	X	RUSH TURNAROUND	002
BPSOU-KAW-3		08/10/21	12:40	X				2					X	X	RUSH TURNAROUND	003
BPSOU-KAW-4		08/10/21	12:45	X				2					X	X	RUSH TURNAROUND	004
BPSOU-KAW-5		08/10/21	12:50	X				2					X	X	RUSH TURNAROUND	005
BPSOU-KAW-6		08/10/21	12:55	X				2					X	X	RUSH TURNAROUND	006
BPSOU-KAW-7		08/10/21	13:00	X				2					X	X	RUSH TURNAROUND	007
BPSOU-KAW-8		08/10/21	13:05	X				2					X	X	RUSH TURNAROUND	008

Sampler's Name:	Kile Denney	Relinquished By / Affiliation		Date	Time	Accepted By / Affiliation	Date	Time
Sampler's Company:	Pioneer Technical Services			8/11/21	1600	Jesse Schwarzrock / PACE	8/12/21	850
Shipment Method:	FedEx Overnight							
Shipment Tracking No.:	9950 9946 8703							
Special Instructions:								



Document Name:
Sample Condition Upon Receipt (SCUR) - ESI
 Document No.:
ENV-FRM-MIN4-0149 Rev.01

Document Revised: 12Aug2020
Page 1 of 1
 Pace Analytical Services -
Minneapolis

**Sample Condition
 Upon Receipt - ESI
 Tech Specs**

Client Name:

Project #:

BP - Pioneer

WO#: 10574177

PM: JMA Due Date: 08/19/21
 CLIENT: BP-PIONEER

Courier: Fed Ex UPS USPS Client
 Pace SpeedDee Commercial

Tracking Number: 9550 9946 8703 See Exceptions
 ENV-FRM-MIN4-0142

Custody Seal on Cooler/Box Present? Yes No Seals Intact? Yes No Biological Tissue Frozen? Yes No N/A

Packing Material: Bubble Wrap Bubble Bags None Other: _____ Temp Blank? Yes No

Thermometer: T1(0461) T2(1336) T3(0459) Type of Ice: Wet Blue None Dry Melted
 T4(0254) T5(0489)

Temp should be above freezing to 6°C Cooler Temp Read w/temp blank: 2.9 °C Average Corrected Temp (no temp blank only): _____ °C See Exceptions ENV-FRM-MIN4-0142 1 Container
 Correction Factor: true Cooler Temp Corrected w/temp blank: 2.9 °C

USDA Regulated Soil: (N/A, water sample/Other: _____) Date/Initials of Person Examining Contents: HB 8/10/21
 Did samples originate in a quarantine zone within the United States: AL, AR, CA, FL, GA, ID, LA, MS, NC, NM, NY, OK, OR, SC, TN, TX or VA (check maps)? Yes No Did samples originate from a foreign source (internationally, including Hawaii and Puerto Rico)? Yes No
If Yes to either question, fill out a Regulated Soil Checklist (F-MN-Q-338) and include with SCUR/COC paperwork.

	COMMENTS:
Chain of Custody Present and Filled Out? <input checked="" type="checkbox"/> Yes <input type="checkbox"/> No	1.
Chain of Custody Relinquished? <input checked="" type="checkbox"/> Yes <input type="checkbox"/> No	2.
Sampler Name and/or Signature on COC? <input checked="" type="checkbox"/> Yes <input type="checkbox"/> No <input type="checkbox"/> N/A	3.
Samples Arrived within Hold Time? <input checked="" type="checkbox"/> Yes <input type="checkbox"/> No	4.
Short Hold Time Analysis (<72 hr)? <input type="checkbox"/> Yes <input checked="" type="checkbox"/> No	5. <input type="checkbox"/> Fecal Coliform <input type="checkbox"/> HPC <input type="checkbox"/> Total Coliform/E coli <input type="checkbox"/> BOD/cBOD <input type="checkbox"/> Hex Chrome <input type="checkbox"/> Turbidity <input type="checkbox"/> Nitrate <input type="checkbox"/> Nitrite <input type="checkbox"/> Orthophos <input type="checkbox"/>
Rush Turn Around Time Requested? <input checked="" type="checkbox"/> Yes <input type="checkbox"/> No	6.
Sufficient Sample Volume? <input checked="" type="checkbox"/> Yes <input type="checkbox"/> No	7.
Triple Volume Provided for MS/MSD (if more than 10 samples)? <input type="checkbox"/> Yes <input type="checkbox"/> No <input checked="" type="checkbox"/> N/A	
Correct Containers Used? <input checked="" type="checkbox"/> Yes <input type="checkbox"/> No	8.
-Pace Containers Used? <input checked="" type="checkbox"/> Yes <input type="checkbox"/> No	
Containers Intact? <input checked="" type="checkbox"/> Yes <input type="checkbox"/> No	9.
Field Filtered Volume Received for Dissolved Tests? <input type="checkbox"/> Yes <input type="checkbox"/> No <input checked="" type="checkbox"/> N/A	10. Is sediment visible in the dissolved container? <input type="checkbox"/> Yes <input type="checkbox"/> No
Is sufficient information available to reconcile the samples to the COC <input checked="" type="checkbox"/> Yes <input type="checkbox"/> No	11. If no, write ID/ Date/Time on Container Below: <input type="checkbox"/> See Exception ENV-FRM-MIN4-0142
Matrix: <input type="checkbox"/> Water <input checked="" type="checkbox"/> Soil <input type="checkbox"/> Oil <input type="checkbox"/> Other _____	12. Sample # <input type="checkbox"/> NaOH <input type="checkbox"/> HNO ₃ <input type="checkbox"/> H ₂ SO ₄ <input type="checkbox"/> Zinc Acetate Positive for Res. <input type="checkbox"/> Yes <input type="checkbox"/> No <input type="checkbox"/> See Exception ENV-FRM-MIN4-0142 Chlorine? <input type="checkbox"/> No pH Paper Lot# Res. Chlorine 0-6 Roll 0-6 Strip 0-14 Strip
All containers needing acid/base preservation have been checked? <input type="checkbox"/> Yes <input type="checkbox"/> No <input checked="" type="checkbox"/> N/A	
All containers needing preservation are found to be in compliance with EPA recommendation? (HNO ₃ , H ₂ SO ₄ , <2pH, NaOH >9 Sulfide, NaOH >10 Cyanide) <input type="checkbox"/> Yes <input type="checkbox"/> No <input checked="" type="checkbox"/> N/A Exceptions: VOA, Coliform, TOC/DOC Oil and Grease, DRO/8015 (water) and Dioxin/PFAS *If adding preservative to a container it must be added to associated field and equipment blanks (verify with PM first) <input type="checkbox"/> Yes <input type="checkbox"/> No <input checked="" type="checkbox"/> N/A	
Extra labels present on soil VOA or WIDRO containers? <input type="checkbox"/> Yes <input type="checkbox"/> No <input checked="" type="checkbox"/> N/A	13. <input type="checkbox"/> See Exception ENV-FRM-MIN4-0140
Headspace in VOA Vials (greater than 6mm)? <input type="checkbox"/> Yes <input type="checkbox"/> No <input checked="" type="checkbox"/> N/A	
3 Trip Blanks Present? <input type="checkbox"/> Yes <input type="checkbox"/> No <input checked="" type="checkbox"/> N/A	14. Pace Trip Blank Lot # (if purchased): _____
Trip Blank Custody Seals Present? <input type="checkbox"/> Yes <input type="checkbox"/> No <input checked="" type="checkbox"/> N/A	

Temp Log: Temp must be maintained at <6°C during login, record temp every 20 mins		
Opened Time: <u>1145</u>	Temp: <u>2.9</u>	Corrected Temp: <u>2.9</u>
Time: _____	put in cooler	
Time: <u>1158</u>	Temp: <u>3.0</u>	Corrected Temp: <u>3.0</u>

CLIENT NOTIFICATION/RESOLUTION

Field Data Required? Yes No

Person Contacted:

Date/Time:

Comments/Resolution:

Project Manager Review:

Date: 08/16/2021

Note: Whenever there is a discrepancy affecting North Carolina compliance samples, a copy of this form will be sent to the North Carolina DEHNR Certification Office (i.e. out of hold, incorrect preservative, out of temp, incorrect containers)

Labeled by: HB (2)

Internal Transfer Chain of Custody

40231493

Pace Analytical
 www.pacelabs.com

Samples Pre-Logged into eCOC.

State Of Origin: MT

Cert. Needed: Yes No

Workorder: 10574177 Workorder Name: BPSOU School Sampling

Owner Received Date: 8/12/2021 Results Requested By: 8/19/2021



Report To: Subcontract To: Requested Analysis:

Jennifer Anderson
 Pace Analytical Minnesota
 1700 Elm Street
 Minneapolis, MN 55414
 Phone (612)607-6436

Pace Analytical Green Bay
 1241 Bellevue Street
 Suite 9
 Green Bay, WI 54302
 Phone (920)469-2436

PB

Item	Sample ID	Sample Type	Collect Date/Time	Lab ID	Matrix	Preserved Containers		LAB USE ONLY
						Other		
1	BPSOU-KAW-1	PS	8/10/2021 12:30	10574177001	Solid	1		001
2	BPSOU-KAW-2	PS	8/10/2021 12:35	10574177003	Solid	1		002
3	BPSOU-KAW-3	PS	8/10/2021 12:40	10574177005	Solid	1		003
4	BPSOU-KAW-4	PS	8/10/2021 12:45	10574177007	Solid	1		004
5	BPSOU-KAW-5	PS	8/10/2021 12:50	10574177009	Solid	1		005
6	BPSOU-KAW-6	PS	8/10/2021 12:55	10574177011	Solid	1		006
7	BPSOU-KAW-7	PS	8/10/2021 13:00	10574177013	Solid	1		007
8	BPSOU-KAW-8	PS	8/10/2021 13:05	10574177015	Solid	1		008

Air Dry & Sieve

Comments

Transfers	Released By	Date/Time	Received By	Date/Time	IR40-Rush	Include soil prep log	Follow QAPP	Samples Intact	Y or N
1	FedEx	8/13/21 0940	Heather Pace	8/13/21 0940	#60 Sieve			Y	N
2									
3									

Cooler Temperature on Receipt N/A °C Custody Seal Y or N Received on Ice Y or N

***In order to maintain client confidentiality, location/name of the sampling site, sampler's name and signature may not be provided on this COC document.

This chain of custody is considered complete as is since this information is available in the owner laboratory.



Laboratory Management Program LaMP Chain of Custody Record

40231483
 Source: Mike
 Page 1 of 1
 Rush TAT: XX No

Req Due Date (mm/dd/yy):
 Lab Work Order Number:

Lab Name: Pace Analytical Services		Facility Address:		Consultant/Contractor: Pioneer Technical Services			
Lab Address: 1700 Elm Street Minneapolis, MN 55414		City, State, ZIP Code:		Consultant/Contractor Project No: BPSOU School Sampling			
Lab PM: Jennifer Anderson		Lead Regulatory Agency:		Address: 307 E Park Suite 421, Anaconda MT, 59711			
Lab Phone: 612-607-1700		California Global ID No.:		Consultant/Contractor PM: Jesse Schwarzrock			
Lab Shipping Acct:		Enfos Proposal No.:		Phone: 406-697-0949 Email: jschwarzrock@pioneer-technical.com			
Lab Bottle Order No.:		Accounting Mode:		Email EDD To: Jesse Schwarzrock			
Other Info:		Stage:		Invoice To: BP Contractor X			
BP Project Manager (PM): Mike Mc Anulty		Matrix		Requested Analyses			
BP PM Phone: 406-723-1822		Is this location a well?		Report Type & QC Level			
BP PM Email: mcanu@bp.com		Water / Liquid		Standard X			
		Air / Vapor		Full Data Package			
		Total Number of Containers		Note: If sample not collected, indicate "No"			
		Unpreserved		Comments			
		H2SO4					
		HNO3					
		HCl					
		Methanol					
		Air dry&sieve*, 6020 (As, Cd, Cu, Pb, Zn)					
		7471 Mercury, dry weight					
Lab No.	Sample Description	Date	Time	Relinquished By / Affiliation	Date	Time	
	BPSOU-KAW-1	08/10/21	12:30				
	BPSOU-KAW-2	08/10/21	12:35				
	BPSOU-KAW-3	08/10/21	12:40				
	BPSOU-KAW-4	08/10/21	12:45				
	BPSOU-KAW-5	08/10/21	12:50				
	BPSOU-KAW-6	08/10/21	12:55				
	BPSOU-KAW-7	08/10/21	13:00				
	BPSOU-KAW-8	08/10/21	13:05				
Sampler's Name: Kile Denney		Relinquished By / Affiliation		Accepted By / Affiliation		Date	
Sampler's Company: Pioneer Technical Services		FedEx		K. Jensen		8/13/21 0940	
Shipment Method: FedEx Overnight		Ship Date: 8/11/21		Date		Time	
Shipment Tracking No: 9950 9446 9537		Date		Time		Date	
Special Instructions:		Temp Blank: Yes / No		Cooler Temp on Receipt: °F/C		MS/MSD Sample Submitted: Yes / No	
THIS LINE - LAB USE ONLY: Custody Seals in Place: Yes / No		Temp Blank: Yes / No		Cooler Temp on Receipt: °F/C		MS/MSD Sample Submitted: Yes / No	

Sample Preservation Receipt Form

Client Name: Pace Minn Project # 40231493

Lab Lot# of pH paper: _____ Lab Std #ID of preservation (if pH adjusted): _____

All containers needing preservation have been checked and noted below: Yes No NA
 Initial when completed: _____ Date/ Time: _____

Pace Lab #	Glass				Plastic				Vials				Jars			General		VOA Vials (>6mm) *	H2SO4 pH ≤2	NaOH+Zn Act pH ≥9	NaOH pH ≥12	HNO3 pH ≤2	pH after adjusted	Volume (mL)		
	AG1U	BG1U	AG1H	AG4S	AG4U	AG5U	AG2S	BG3U	BP1U	BP3U	BP3B	BP3N	BP3S	VG9A	DG9T	VG9U	VG9H								VG9M	VG9D
001																										2.5/5/10
002																										2.5/5/10
003																										2.5/5/10
004																										2.5/5/10
005																										2.5/5/10
006																										2.5/5/10
007																										2.5/5/10
008																										2.6/6/10
009																										2.5/5/10
010																										2.5/5/10
011																										2.5/5/10
012																										2.5/5/10
013																										2.5/5/10
014																										2.5/5/10
015																										2.5/5/10
016																										2.5/5/10
017																										2.5/5/10
018																										2.5/5/10
019																										2.5/5/10
020																										2.5/5/10

VP
 8/13/21

Exceptions to preservation check: VOA, Coliform, TOC, TOX, TOH, O&G, WI DRO, Phenolics, Other: _____ Headspace in VOA Vials (>6mm): Yes No *If yes look in headspace column

AG1U	1 liter amber glass	BP1U	1 liter plastic unpres	VG9A	40 mL clear ascorbic	JGFU	4 oz amber jar unpres
BG1U	1 liter clear glass	BP3U	250 mL plastic unpres	DG9T	40 mL amber Na Thio	JG9U	9 oz amber jar unpres
AG1H	1 liter amber glass HCL	BP3B	250 mL plastic NaOH	VG9U	40 mL clear vial unpres	WGFU	4 oz clear jar unpres
AG4S	125 mL amber glass H2SO4	BP3N	250 mL plastic HNO3	VG9H	40 mL clear vial HCL	WPFU	4 oz plastic jar unpres
AG4U	120 mL amber glass unpres	BP3S	250 mL plastic H2SO4	VG9M	40 mL clear vial MeOH	SP5T	120 mL plastic Na Thiosulfate
AG5U	100 mL amber glass unpres			VG9D	40 mL clear vial DI	ZPLC	ziploc bag
AG2S	500 mL amber glass H2SO4					GN	
EG3U	250 mL clear glass unpres						



Document Name:
Sample Condition Upon Receipt (SCUR)
 Document No.:
ENV-FRM-GBAY-0014-Rev.00

Document Revised: 26Mar2020
 Author:
 Pace Green Bay Quality Office

Sample Condition Upon Receipt Form (SCUR)

Project #: _____

Client Name: Pace Minn

WO# : 40231493

Courier: CS Logistics Fed Ex Speedee UPS Walco
 Client Pace Other: _____



Tracking #: 9550 9946 9537

Custody Seal on Cooler/Box Present: yes no Seals intact: yes no

Custody Seal on Samples Present: yes no Seals intact: yes no

Packing Material: Bubble Wrap Bubble Bags None Other

Thermometer Used SR - 90 N/A Type of Ice: Wet Blue Dry (None) Samples on ice, cooling process has begun

Cooler Temperature Uncorr: N/A / Corr: N/A

Temp Blank Present: yes no

Biological Tissue is Frozen: yes no

Person examining contents:
 Date: 8/13/21 / Initials: HB
 Labeled By Initials: HB

Temp should be above freezing to 6°C.
 Biota Samples may be received at ≤ 0°C if shipped on Dry Ice.

Chain of Custody Present:	<input checked="" type="checkbox"/> Yes <input type="checkbox"/> No <input type="checkbox"/> N/A	1.
Chain of Custody Filled Out:	<input checked="" type="checkbox"/> Yes <input type="checkbox"/> No <input type="checkbox"/> N/A	2.
Chain of Custody Relinquished:	<input checked="" type="checkbox"/> Yes <input type="checkbox"/> No <input type="checkbox"/> N/A	3.
Sampler Name & Signature on COC:	<input type="checkbox"/> Yes <input type="checkbox"/> No <input checked="" type="checkbox"/> N/A	4. <u>IRWD HB 8/13/21</u>
Samples Arrived within Hold Time:	<input checked="" type="checkbox"/> Yes <input type="checkbox"/> No	5.
- VOA Samples frozen upon receipt	<input type="checkbox"/> Yes <input type="checkbox"/> No	Date/Time:
Short Hold Time Analysis (<72hr):	<input type="checkbox"/> Yes <input checked="" type="checkbox"/> No	6.
Rush Turn Around Time Requested:	<input checked="" type="checkbox"/> Yes <input checked="" type="checkbox"/> No <u>8/13/21</u>	7.
Sufficient Volume:		8.
For Analysis: <input checked="" type="checkbox"/> Yes <input type="checkbox"/> No MS/MSD: <input type="checkbox"/> Yes <input checked="" type="checkbox"/> No <input type="checkbox"/> N/A		
Correct Containers Used:	<input checked="" type="checkbox"/> Yes <input type="checkbox"/> No	9.
-Pace Containers Used:	<input type="checkbox"/> Yes <input type="checkbox"/> No <input checked="" type="checkbox"/> N/A	
-Pace IR Containers Used:	<input type="checkbox"/> Yes <input checked="" type="checkbox"/> No <input type="checkbox"/> N/A	
Containers Intact:	<input checked="" type="checkbox"/> Yes <input type="checkbox"/> No	10.
Filtered volume received for Dissolved tests	<input type="checkbox"/> Yes <input type="checkbox"/> No <input checked="" type="checkbox"/> N/A	11.
Sample Labels match COC:	<input checked="" type="checkbox"/> Yes <input checked="" type="checkbox"/> No <input type="checkbox"/> N/A	12. <u>005 time 12:4 HB 8/13/21</u>
-Includes date/time/ID/Analysis Matrix: <u>S</u>		
Trip Blank Present:	<input type="checkbox"/> Yes <input type="checkbox"/> No <input checked="" type="checkbox"/> N/A	13.
Trip Blank Custody Seals Present	<input type="checkbox"/> Yes <input type="checkbox"/> No <input checked="" type="checkbox"/> N/A	
Pace Trip Blank Lot # (if purchased):		

Client Notification/ Resolution: _____
 Person Contacted: _____ Date/Time: _____
 Comments/ Resolution: _____

PM Review is documented electronically in LIMs. By releasing the project, the PM acknowledges they have reviewed the sample logir

Internal Transfer Chain of Custody

40231493



Samples Pre-Logged into eCOC.

State Of Origin: MT

Cert. Needed: Yes No

Owner Received Date: 8/12/2021 Results Requested By: 8/19/2021



Workorder Name: BPSOU School Sampling

Report To: Subcontract To

Jennifer Anderson
Pace Analytical Minnesota
1700 Elm Street
Minneapolis, MN 55414
Phone (612)607-6436

Pace Analytical Green Bay
1241 Bellevue Street
Suite 9
Green Bay, WI 54302
Phone (920)469-2436

WO#: 10574177

Requested Analysis: Air Dry & Sieve

PB

Item	Sample ID	Sample Type	Collect Date/Time	Lab ID	Matrix	Preserved Containers		LAB USE ONLY
						Other		
1	BPSOU-KAW-1	PS	8/10/2021 12:30	10574177001	Solid	1		001
2	BPSOU-KAW-2	PS	8/10/2021 12:35	10574177003	Solid	1		002
3	BPSOU-KAW-3	PS	8/10/2021 12:40	10574177005	Solid	1		003
4	BPSOU-KAW-4	PS	8/10/2021 12:45	10574177007	Solid	1		004
5	BPSOU-KAW-5	PS	8/10/2021 12:50	10574177009	Solid	1		005
6	BPSOU-KAW-6	PS	8/10/2021 12:55	10574177011	Solid	1		006
7	BPSOU-KAW-7	PS	8/10/2021 13:00	10574177013	Solid	1		007
8	BPSOU-KAW-8	PS	8/10/2021 13:05	10574177015	Solid	1		008

Transfers	Released By	Date/Time	Received By	Date/Time	IR40-Rush	Comments
1	FedEx	8/13/21 0940	Mendez Pace	8/13/21 0940	#60 Sieve	
2	[Signature]	8/16/21 1700	Handy/Pac	8/16/21 1700	Include soil prep log	
3					Follow QAPP	

Cooler Temperature on Receipt: N/A °C Custody Seal: Y N Received on Ice: Y N Samples Intact: Y N

***In order to maintain client confidentiality, location/name of the sampling site, sampler's name and signature may not be provided on this COC document. This chain of custody is considered complete as is since this information is available in the owner laboratory.

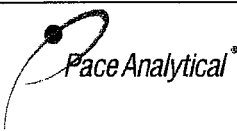

Document Name: Sample Condition Upon Receipt (SCUR) - MN

Document Revised: 14Apr2021

Page 1 of 1

Document No.: ENV-FRM-MIN4-0150 Rev.02

Pace Analytical Services - Minneapolis

Sample Condition Upon Receipt

Client Name:

Pace Green Bay

Project #:

WO#: 10574177

Courier:

Fed Ex, UPS, USPS, Client, Pace, Speedee, Commercial

PM: JMA Due Date: 08/19/21

CLIENT: BP-PIONEER

Tracking Number:

2937186-1

See Exceptions ENV-FRM-MIN4-0142

Custody Seal on Cooler/Box Present? Yes No Seals Intact? Yes No Biological Tissue Frozen? Yes No N/A

Packing Material: Bubble Wrap, Bubble Bags, None, Other Temp Blank? Yes No

Thermometer: T1(0461), T2(1336), T3(0459), OS418-LS, T4(0254), T5(0489), 160285052 Type of Ice: Wet, Blue, None, Dry, Melted

Did Samples Originate in West Virginia? Yes No Were All Container Temps Taken? Yes No N/A

Temp should be above freezing to 6°C Cooler Temp Read w/temp blank: Average Corrected Temp (no temp blank only): 19.7°C See Exceptions ENV-FRM-MIN4-0142 1 Container

USDA Regulated Soil: N/A, water sample/Other: Date/Initials of Person Examining Contents: HKB 8/17/21

Did samples originate in a quarantine zone within the United States: AL, AR, CA, FL, GA, ID, LA, MS, NC, NM, NY, OK, OR, SC, TN, TX or VA (check maps)? Yes No Did samples originate from a foreign source (internationally, including Hawaii and Puerto Rico)? Yes No

If Yes to either question, fill out a Regulated Soil Checklist (F-MN-Q-338) and include with SCUR/COC paperwork.

Table with 2 columns: Questions and COMMENTS. Contains 14 rows of questions related to sample handling, custody, and analysis.

CLIENT NOTIFICATION/RESOLUTION

Person Contacted: Comments/Resolution:

Field Data Required? Yes No

Date/Time:

Project Manager Review:

Date: 08/19/2021

Note: Whenever there is a discrepancy... a copy of this form will be sent to the North Carolina DEHNR Certification Office (i.e. out of hold, incorrect preservative, out of temp, incorrect containers).

Labeled by: HKB



SCUR Exceptions:

Workorder #: 10574177

Out of Temp Sample IDs	Container Type	# of Containers	PM Notified? <input type="checkbox"/> Yes <input type="checkbox"/> No																
			If yes, indicate who was contacted/date/time. If no, indicate reason why.																
			Multiple Cooler Project? <input type="checkbox"/> Yes <input type="checkbox"/> No If you answered yes, fill out information to the left.																
			<table border="1"> <thead> <tr> <th colspan="3">No Temp Blank</th> </tr> <tr> <th>Read Temp</th> <th>Corrected Temp</th> <th>Average Temp</th> </tr> </thead> <tbody> <tr> <td>19.8</td> <td>T</td> <td>19.7</td> </tr> <tr> <td>19.7</td> <td rowspan="3">↓</td> <td></td> </tr> <tr> <td>19.6</td> <td></td> </tr> <tr> <td>19.6</td> <td></td> </tr> </tbody> </table>	No Temp Blank			Read Temp	Corrected Temp	Average Temp	19.8	T	19.7	19.7	↓		19.6		19.6	
No Temp Blank																			
Read Temp	Corrected Temp	Average Temp																	
19.8	T	19.7																	
19.7	↓																		
19.6																			
19.6																			

Tracking Number/Temperature

Issue Type: Sample ID	Container Type	# of Containers

pH Adjustment Log for Preserved Samples

Sample ID	Type of Preserv.	pH Upon Receipt	Date Adjusted	Time Adjusted	Amount Added (mL)	Lot # Added	pH After	In Compliance after addition? <input type="checkbox"/> Yes <input type="checkbox"/> No	Initials
								<input type="checkbox"/> Yes <input type="checkbox"/> No	
								<input type="checkbox"/> Yes <input type="checkbox"/> No	
								<input type="checkbox"/> Yes <input type="checkbox"/> No	
								<input type="checkbox"/> Yes <input type="checkbox"/> No	

Comments:

ATTACHMENT F
S&N CONCRETE AGGREGATE
STOCKPILE DATA

APPENDIX F - S&N CONCRETE AGGREGATE QA DATA

Sample ID	Date Collected	Butte Hill Reveg Spec:	As	Cd	Cu	Pb	Zn	Hg	
			< 97 mg/kg	< 4 mg/kg	< 250 mg/kg	< 100 mg/kg	< 250 mg/kg	< 5 mg/kg	
1 22-RMAP-SNROAD-1	07/27/22	Volume Tested: Approximatley 10,000 cy	8.1	0.13	36.1	10.0	89.4	0.01	
2 22-RMAP-SNROAD-2	07/27/22		7.4	0.11	32.1	9.0	82.0	0.01	
3 22-RMAP-SNPIT-1	07/27/22		9.2	0.15	45.0	10.9	102.0	0.01	
4 22-RMAP-SNPIT-2	07/27/22		8.3	0.15	42.7	9.8	96.1	0.01	
			MAX:	9.2	0.15	45.0	10.9	102.0	0.01
			MIN:	7.4	0.11	32.1	9.0	82.0	0.01
			AVE:	8.3	0.14	39.0	9.9	92.4	0.01

ATTACHMENT F-1
PACE ANALYTICAL DATA REPORTS

August 16, 2022

Jesse Schwarzrock
Pioneer Technical Services
307 E Park
Suite 421
Anaconda, MT 59711

RE: Project: BPSOU Park Sampling
Pace Project No.: 10618818

Dear Jesse Schwarzrock:

Enclosed are the analytical results for sample(s) received by the laboratory on July 28, 2022. The results relate only to the samples included in this report. Results contained within this report conform to the most current version of the TNI standards, BP LaMP Technical Requirements Revision 12.1, and any applicable Quality Assurance Project Plan (QAPP), or Work Plan unless otherwise narrated in the body of this report.

The test results provided in this final report were generated by each of the following laboratories within the Pace Network:

- Pace Analytical Services - Minneapolis

If you have any questions concerning this report, please feel free to contact me.

Sincerely,



Jennifer Anderson
jennifer.anderson@pacelabs.com
(612)607-6436
Project Manager

Enclosures

cc: Cole Dallaserra, Pioneer Technical
BPEquis UploadEmail, BP EQUIS



REPORT OF LABORATORY ANALYSIS

This report shall not be reproduced, except in full,
without the written consent of Pace Analytical Services, LLC.

CERTIFICATIONS

Project: BPSOU Park Sampling

Pace Project No.: 10618818

Pace Analytical Services, LLC - Minneapolis MN

1700 Elm Street SE, Minneapolis, MN 55414

1800 Elm Street SE, Minneapolis, MN 55414--Satellite Air Lab

A2LA Certification #: 2926.01*

Alabama Certification #: 40770

Alaska Contaminated Sites Certification #: 17-009*

Alaska DW Certification #: MN00064

Arizona Certification #: AZ0014*

Arkansas DW Certification #: MN00064

Arkansas WW Certification #: 88-0680

California Certification #: 2929

Colorado Certification #: MN00064

Connecticut Certification #: PH-0256

EPA Region 8 Tribal Water Systems+Wyoming DW Certification #: via MN 027-053-137

Florida Certification #: E87605*

Georgia Certification #: 959

Hawaii Certification #: MN00064

Idaho Certification #: MN00064

Illinois Certification #: 200011

Indiana Certification #: C-MN-01

Iowa Certification #: 368

Kansas Certification #: E-10167

Kentucky DW Certification #: 90062

Kentucky WW Certification #: 90062

Louisiana DEQ Certification #: AI-03086*

Louisiana DW Certification #: MN00064

Maine Certification #: MN00064*

Maryland Certification #: 322

Michigan Certification #: 9909

Minnesota Certification #: 027-053-137*

Minnesota Dept of Ag Approval: via MN 027-053-137

Minnesota Petrofund Registration #: 1240*

Mississippi Certification #: MN00064

Missouri Certification #: 10100

Montana Certification #: CERT0092

Nebraska Certification #: NE-OS-18-06

Nevada Certification #: MN00064

New Hampshire Certification #: 2081*

New Jersey Certification #: MN002

New York Certification #: 11647*

North Carolina DW Certification #: 27700

North Carolina WW Certification #: 530

North Dakota Certification (A2LA) #: R-036

North Dakota Certification (MN) #: R-036

Ohio DW Certification #: 41244

Ohio VAP Certification (1700) #: CL101

Ohio VAP Certification (1800) #: CL110*

Oklahoma Certification #: 9507*

Oregon Primary Certification #: MN300001

Oregon Secondary Certification #: MN200001*

Pennsylvania Certification #: 68-00563*

Puerto Rico Certification #: MN00064

South Carolina Certification #: 74003001

Tennessee Certification #: TN02818

Texas Certification #: T104704192*

Utah Certification #: MN00064*

Vermont Certification #: VT-027053137

Virginia Certification #: 460163*

Washington Certification #: C486*

West Virginia DEP Certification #: 382

West Virginia DW Certification #: 9952 C

Wisconsin Certification #: 999407970

Wyoming UST Certification #: via A2LA 2926.01

USDA Permit #: P330-19-00208

Please Note: Applicable air certifications are denoted with an asterisk ().

REPORT OF LABORATORY ANALYSIS

This report shall not be reproduced, except in full,
without the written consent of Pace Analytical Services, LLC.

SAMPLE SUMMARY

Project: BPSOU Park Sampling

Pace Project No.: 10618818

Lab ID	Sample ID	Matrix	Date Collected	Date Received
10618818001	22-RMAP-SNROAD-1	Solid	07/27/22 08:00	07/28/22 08:50
10618818002	22-RMAP-SNROAD-1	Solid	07/27/22 08:00	07/28/22 08:50
10618818003	22-RMAP-SNROAD-2	Solid	07/27/22 08:05	07/28/22 08:50
10618818004	22-RMAP-SNROAD-2	Solid	07/27/22 08:05	07/28/22 08:50
10618818005	22-RMAP-SNPIT-1	Solid	07/27/22 08:15	07/28/22 08:50
10618818006	22-RMAP-SNPIT-1	Solid	07/27/22 08:15	07/28/22 08:50
10618818007	22-RMAP-SNPIT-2	Solid	07/27/22 08:20	07/28/22 08:50
10618818008	22-RMAP-SNPIT-2	Solid	07/27/22 08:20	07/28/22 08:50

REPORT OF LABORATORY ANALYSIS

This report shall not be reproduced, except in full,
without the written consent of Pace Analytical Services, LLC.

SAMPLE ANALYTE COUNT

Project: BPSOU Park Sampling

Pace Project No.: 10618818

Lab ID	Sample ID	Method	Analysts	Analytes Reported	Laboratory
10618818001	22-RMAP-SNROAD-1	EPA 6020A	NN2	5	PASI-M
10618818002	22-RMAP-SNROAD-1	EPA 7471B	LMW	1	PASI-M
		ASTM D2974	JDL	1	PASI-M
10618818003	22-RMAP-SNROAD-2	EPA 6020A	NN2	5	PASI-M
10618818004	22-RMAP-SNROAD-2	EPA 7471B	LMW	1	PASI-M
		ASTM D2974	JDL	1	PASI-M
10618818005	22-RMAP-SNPIT-1	EPA 6020A	NN2	5	PASI-M
10618818006	22-RMAP-SNPIT-1	EPA 7471B	LMW	1	PASI-M
		ASTM D2974	JDL	1	PASI-M
10618818007	22-RMAP-SNPIT-2	EPA 6020A	NN2	5	PASI-M
10618818008	22-RMAP-SNPIT-2	EPA 7471B	LMW	1	PASI-M
		ASTM D2974	JDL	1	PASI-M

PASI-M = Pace Analytical Services - Minneapolis

REPORT OF LABORATORY ANALYSIS

This report shall not be reproduced, except in full,
without the written consent of Pace Analytical Services, LLC.

PROJECT NARRATIVE

Project: BPSOU Park Sampling

Pace Project No.: 10618818

Date: August 16, 2022

Samples analyzed for method 6020 were analyzed after they were dried and sieved using a number 60 sieve.

REPORT OF LABORATORY ANALYSIS

This report shall not be reproduced, except in full,
without the written consent of Pace Analytical Services, LLC.

PROJECT NARRATIVE

Project: BPSOU Park Sampling

Pace Project No.: 10618818

Method: EPA 6020A

Description: 6020A MET ICPMS

Client: BPAR-PIONEER-MT

Date: August 16, 2022

General Information:

4 samples were analyzed for EPA 6020A by Pace Analytical Services Minneapolis. All samples were received in acceptable condition with any exceptions noted below or on the chain-of custody and/or the sample condition upon receipt form (SCUR) attached at the end of this report.

Hold Time:

The samples were analyzed within the method required hold times with any exceptions noted below.

Sample Preparation:

The samples were prepared in accordance with EPA 3050B with any exceptions noted below.

Initial Calibrations (including MS Tune as applicable):

All criteria were within method requirements with any exceptions noted below.

Continuing Calibration:

All criteria were within method requirements with any exceptions noted below.

Internal Standards:

All internal standards were within QC limits with any exceptions noted below.

Method Blank:

All analytes were below the report limit in the method blank, where applicable, with any exceptions noted below.

Laboratory Control Spike:

All laboratory control spike compounds were within QC limits with any exceptions noted below.

Matrix Spikes:

All percent recoveries and relative percent differences (RPDs) were within acceptance criteria with any exceptions noted below.

Duplicate Sample:

All duplicate sample results were within method acceptance criteria with any exceptions noted below.

Additional Comments:

REPORT OF LABORATORY ANALYSIS

This report shall not be reproduced, except in full,
without the written consent of Pace Analytical Services, LLC.

PROJECT NARRATIVE

Project: BPSOU Park Sampling

Pace Project No.: 10618818

Method: EPA 7471B

Description: 7471B Mercury

Client: BPAR-PIONEER-MT

Date: August 16, 2022

General Information:

4 samples were analyzed for EPA 7471B by Pace Analytical Services Minneapolis. All samples were received in acceptable condition with any exceptions noted below or on the chain-of custody and/or the sample condition upon receipt form (SCUR) attached at the end of this report.

Hold Time:

The samples were analyzed within the method required hold times with any exceptions noted below.

Sample Preparation:

The samples were prepared in accordance with EPA 7471B with any exceptions noted below.

Initial Calibrations (including MS Tune as applicable):

All criteria were within method requirements with any exceptions noted below.

Continuing Calibration:

All criteria were within method requirements with any exceptions noted below.

Method Blank:

All analytes were below the report limit in the method blank, where applicable, with any exceptions noted below.

Laboratory Control Spike:

All laboratory control spike compounds were within QC limits with any exceptions noted below.

Matrix Spikes:

All percent recoveries and relative percent differences (RPDs) were within acceptance criteria with any exceptions noted below.

Duplicate Sample:

All duplicate sample results were within method acceptance criteria with any exceptions noted below.

Additional Comments:

This data package has been reviewed for quality and completeness and is approved for release.

REPORT OF LABORATORY ANALYSIS

This report shall not be reproduced, except in full,
without the written consent of Pace Analytical Services, LLC.

ANALYTICAL RESULTS

Project: BPSOU Park Sampling

Pace Project No.: 10618818

Sample: 22-RMAP-SNROAD-1 **Lab ID: 10618818001** Collected: 07/27/22 08:00 Received: 07/28/22 08:50 Matrix: Solid

Results reported on a "wet-weight" basis

Parameters	Results	Units	PQL	MDL	DF	Prepared	Analyzed	CAS No.	Qual
6020A MET ICPMS									
Analytical Method: EPA 6020A Preparation Method: EPA 3050B									
Pace Analytical Services - Minneapolis									
Arsenic	8.1	mg/kg	0.49	0.14	1	08/11/22 18:24	08/16/22 00:15	7440-38-2	
Cadmium	0.13	mg/kg	0.078	0.029	1	08/11/22 18:24	08/16/22 00:15	7440-43-9	
Copper	36.1	mg/kg	0.97	0.30	1	08/11/22 18:24	08/16/22 00:15	7440-50-8	
Lead	10	mg/kg	2.4	0.45	5	08/11/22 18:24	08/12/22 19:48	7439-92-1	
Zinc	89.4	mg/kg	4.9	1.1	1	08/11/22 18:24	08/16/22 00:15	7440-66-6	

REPORT OF LABORATORY ANALYSIS

This report shall not be reproduced, except in full,
without the written consent of Pace Analytical Services, LLC.

ANALYTICAL RESULTS

Project: BPSOU Park Sampling

Pace Project No.: 10618818

Sample: 22-RMAP-SNROAD-1 **Lab ID: 10618818002** Collected: 07/27/22 08:00 Received: 07/28/22 08:50 Matrix: Solid

Results reported on a "dry weight" basis and are adjusted for percent moisture, sample size and any dilutions.

Parameters	Results	Units	PQL	MDL	DF	Prepared	Analyzed	CAS No.	Qual
7471B Mercury	Analytical Method: EPA 7471B Preparation Method: EPA 7471B Pace Analytical Services - Minneapolis								
Mercury	<0.0087	mg/kg	0.020	0.0087	1	08/09/22 14:37	08/10/22 15:32	7439-97-6	
Dry Weight / %M by ASTM D2974	Analytical Method: ASTM D2974 Pace Analytical Services - Minneapolis								
Percent Moisture	0.63	%	0.10	0.10	1		08/04/22 13:09		N2

REPORT OF LABORATORY ANALYSIS

This report shall not be reproduced, except in full,
without the written consent of Pace Analytical Services, LLC.

ANALYTICAL RESULTS

Project: BPSOU Park Sampling

Pace Project No.: 10618818

Sample: 22-RMAP-SNROAD-2 **Lab ID: 10618818003** Collected: 07/27/22 08:05 Received: 07/28/22 08:50 Matrix: Solid

Results reported on a "wet-weight" basis

Parameters	Results	Units	PQL	MDL	DF	Prepared	Analyzed	CAS No.	Qual
6020A MET ICPMS									
Analytical Method: EPA 6020A Preparation Method: EPA 3050B									
Pace Analytical Services - Minneapolis									
Arsenic	7.4	mg/kg	0.46	0.13	1	08/11/22 18:24	08/16/22 00:18	7440-38-2	
Cadmium	0.11	mg/kg	0.074	0.027	1	08/11/22 18:24	08/16/22 00:18	7440-43-9	
Copper	32.1	mg/kg	0.93	0.28	1	08/11/22 18:24	08/16/22 00:18	7440-50-8	
Lead	9.0	mg/kg	2.3	0.43	5	08/11/22 18:24	08/12/22 19:52	7439-92-1	
Zinc	82.0	mg/kg	4.6	1.1	1	08/11/22 18:24	08/16/22 00:18	7440-66-6	

REPORT OF LABORATORY ANALYSIS

This report shall not be reproduced, except in full,
without the written consent of Pace Analytical Services, LLC.

ANALYTICAL RESULTS

Project: BPSOU Park Sampling

Pace Project No.: 10618818

Sample: 22-RMAP-SNROAD-2 **Lab ID: 10618818004** Collected: 07/27/22 08:05 Received: 07/28/22 08:50 Matrix: Solid

Results reported on a "dry weight" basis and are adjusted for percent moisture, sample size and any dilutions.

Parameters	Results	Units	PQL	MDL	DF	Prepared	Analyzed	CAS No.	Qual
7471B Mercury	Analytical Method: EPA 7471B Preparation Method: EPA 7471B Pace Analytical Services - Minneapolis								
Mercury	0.010J	mg/kg	0.018	0.0080	1	08/09/22 14:37	08/10/22 15:33	7439-97-6	
Dry Weight / %M by ASTM D2974	Analytical Method: ASTM D2974 Pace Analytical Services - Minneapolis								
Percent Moisture	0.78	%	0.10	0.10	1		08/04/22 13:09		N2

REPORT OF LABORATORY ANALYSIS

This report shall not be reproduced, except in full,
without the written consent of Pace Analytical Services, LLC.

ANALYTICAL RESULTS

Project: BPSOU Park Sampling

Pace Project No.: 10618818

Sample: 22-RMAP-SNPIT-1 **Lab ID: 10618818005** Collected: 07/27/22 08:15 Received: 07/28/22 08:50 Matrix: Solid

Results reported on a "wet-weight" basis

Parameters	Results	Units	PQL	MDL	DF	Prepared	Analyzed	CAS No.	Qual
6020A MET ICPMS									
Analytical Method: EPA 6020A Preparation Method: EPA 3050B									
Pace Analytical Services - Minneapolis									
Arsenic	9.2	mg/kg	0.46	0.13	1	08/11/22 18:24	08/16/22 00:22	7440-38-2	
Cadmium	0.15	mg/kg	0.074	0.027	1	08/11/22 18:24	08/16/22 00:22	7440-43-9	
Copper	45.0	mg/kg	0.93	0.28	1	08/11/22 18:24	08/16/22 00:22	7440-50-8	
Lead	10.9	mg/kg	2.3	0.43	5	08/11/22 18:24	08/12/22 19:55	7439-92-1	
Zinc	102	mg/kg	4.6	1.1	1	08/11/22 18:24	08/16/22 00:22	7440-66-6	

REPORT OF LABORATORY ANALYSIS

This report shall not be reproduced, except in full,
without the written consent of Pace Analytical Services, LLC.

ANALYTICAL RESULTS

Project: BPSOU Park Sampling

Pace Project No.: 10618818

Sample: 22-RMAP-SNPIT-1 **Lab ID: 10618818006** Collected: 07/27/22 08:15 Received: 07/28/22 08:50 Matrix: Solid

Results reported on a "dry weight" basis and are adjusted for percent moisture, sample size and any dilutions.

Parameters	Results	Units	PQL	MDL	DF	Prepared	Analyzed	CAS No.	Qual
7471B Mercury	Analytical Method: EPA 7471B Preparation Method: EPA 7471B Pace Analytical Services - Minneapolis								
Mercury	0.0096J	mg/kg	0.019	0.0084	1	08/09/22 14:37	08/10/22 15:35	7439-97-6	
Dry Weight / %M by ASTM D2974	Analytical Method: ASTM D2974 Pace Analytical Services - Minneapolis								
Percent Moisture	3.7	%	0.10	0.10	1		08/04/22 13:10		N2

REPORT OF LABORATORY ANALYSIS

This report shall not be reproduced, except in full,
without the written consent of Pace Analytical Services, LLC.

ANALYTICAL RESULTS

Project: BPSOU Park Sampling

Pace Project No.: 10618818

Sample: 22-RMAP-SNPIT-2 **Lab ID: 10618818007** Collected: 07/27/22 08:20 Received: 07/28/22 08:50 Matrix: Solid

Results reported on a "wet-weight" basis

Parameters	Results	Units	PQL	MDL	DF	Prepared	Analyzed	CAS No.	Qual
6020A MET ICPMS									
Analytical Method: EPA 6020A Preparation Method: EPA 3050B									
Pace Analytical Services - Minneapolis									
Arsenic	8.3	mg/kg	0.49	0.14	1	08/11/22 18:24	08/16/22 00:25	7440-38-2	
Cadmium	0.15	mg/kg	0.078	0.029	1	08/11/22 18:24	08/16/22 00:25	7440-43-9	
Copper	42.7	mg/kg	0.98	0.30	1	08/11/22 18:24	08/16/22 00:25	7440-50-8	
Lead	9.8	mg/kg	2.5	0.46	5	08/11/22 18:24	08/12/22 19:59	7439-92-1	
Zinc	96.1	mg/kg	4.9	1.2	1	08/11/22 18:24	08/16/22 00:25	7440-66-6	

REPORT OF LABORATORY ANALYSIS

This report shall not be reproduced, except in full,
without the written consent of Pace Analytical Services, LLC.

ANALYTICAL RESULTS

Project: BPSOU Park Sampling

Pace Project No.: 10618818

Sample: 22-RMAP-SNPIT-2 **Lab ID: 10618818008** Collected: 07/27/22 08:20 Received: 07/28/22 08:50 Matrix: Solid

Results reported on a "dry weight" basis and are adjusted for percent moisture, sample size and any dilutions.

Parameters	Results	Units	PQL	MDL	DF	Prepared	Analyzed	CAS No.	Qual
7471B Mercury	Analytical Method: EPA 7471B Preparation Method: EPA 7471B Pace Analytical Services - Minneapolis								
Mercury	0.011J	mg/kg	0.018	0.0079	1	08/09/22 14:37	08/10/22 15:36	7439-97-6	
Dry Weight / %M by ASTM D2974	Analytical Method: ASTM D2974 Pace Analytical Services - Minneapolis								
Percent Moisture	2.9	%	0.10	0.10	1		08/04/22 13:10		N2

REPORT OF LABORATORY ANALYSIS

This report shall not be reproduced, except in full,
without the written consent of Pace Analytical Services, LLC.

QUALITY CONTROL DATA

Project: BPSOU Park Sampling

Pace Project No.: 10618818

QC Batch: 832541	Analysis Method: EPA 7471B
QC Batch Method: EPA 7471B	Analysis Description: 7471B Mercury Solids
	Laboratory: Pace Analytical Services - Minneapolis

Associated Lab Samples: 10618818002, 10618818004, 10618818006, 10618818008

METHOD BLANK: 4409993 Matrix: Solid
Associated Lab Samples: 10618818002, 10618818004, 10618818006, 10618818008

Parameter	Units	Blank Result	Reporting Limit	MDL	Analyzed	Qualifiers
Mercury	mg/kg	<0.0085	0.020	0.0085	08/09/22 18:40	

LABORATORY CONTROL SAMPLE: 4409994

Parameter	Units	Spike Conc.	LCS Result	LCS % Rec	% Rec Limits	Qualifiers
Mercury	mg/kg	0.49	0.51	105	80-120	

MATRIX SPIKE & MATRIX SPIKE DUPLICATE: 4409996 4409997

Parameter	Units	10618797002 Result	MS Spike Conc.	MSD Spike Conc.	MS Result	MSD Result	MS % Rec	MSD % Rec	% Rec Limits	RPD	Max RPD	Qual
Mercury	mg/kg	0.027	0.65	0.68	0.81	0.81	120	114	80-120	1	20	

SAMPLE DUPLICATE: 4409995

Parameter	Units	10618797002 Result	Dup Result	RPD	Max RPD	Qualifiers
Mercury	mg/kg	0.027	0.028	4	20	

Results presented on this page are in the units indicated by the "Units" column except where an alternate unit is presented to the right of the result.

REPORT OF LABORATORY ANALYSIS

This report shall not be reproduced, except in full,
without the written consent of Pace Analytical Services, LLC.

QUALITY CONTROL DATA

Project: BPSOU Park Sampling

Pace Project No.: 10618818

QC Batch: 832536

Analysis Method: EPA 6020A

QC Batch Method: EPA 3050B

Analysis Description: 6020A Solids UPD4

Laboratory: Pace Analytical Services - Minneapolis

Associated Lab Samples: 10618818001, 10618818003, 10618818005, 10618818007

METHOD BLANK: 4409975

Matrix: Solid

Associated Lab Samples: 10618818001, 10618818003, 10618818005, 10618818007

Parameter	Units	Blank Result	Reporting Limit	MDL	Analyzed	Qualifiers
Arsenic	mg/kg	<0.14	0.50	0.14	08/12/22 18:21	
Cadmium	mg/kg	<0.029	0.080	0.029	08/12/22 18:21	
Copper	mg/kg	<0.31	1.0	0.31	08/12/22 18:21	
Lead	mg/kg	<0.093	0.50	0.093	08/12/22 18:21	
Zinc	mg/kg	1.4J	5.0	1.2	08/12/22 18:21	

LABORATORY CONTROL SAMPLE: 4409976

Parameter	Units	Spike Conc.	LCS Result	LCS % Rec	% Rec Limits	Qualifiers
Arsenic	mg/kg	50	52.7	105	80-120	
Cadmium	mg/kg	50	52.7	105	80-120	
Copper	mg/kg	50	54.4	109	80-120	
Lead	mg/kg	50	56.4	113	80-120	
Zinc	mg/kg	50	53.0	106	80-120	

MATRIX SPIKE & MATRIX SPIKE DUPLICATE: 4409978 4409979

Parameter	Units	MS		MSD		MS % Rec	MSD % Rec	% Rec Limits	RPD	Max RPD	Qual
		10618797001 Result	Spike Conc.	Spike Conc.	Result						
Arsenic	mg/kg	22.9	50	48.1	72.0	73.0	98	104	75-125	2	20
Cadmium	mg/kg	0.83	50	48.1	50.7	51.5	100	105	75-125	2	20
Copper	mg/kg	79.5	50	48.1	129	134	98	113	75-125	4	20
Lead	mg/kg	29.8	50	48.1	84.4	88.8	109	123	75-125	5	20
Zinc	mg/kg	184	50	48.1	226	235	83	106	75-125	4	20

SAMPLE DUPLICATE: 4409977

Parameter	Units	10618797001 Result	Dup Result	RPD	Max RPD	Qualifiers
Arsenic	mg/kg	22.9	23.3	2	20	
Cadmium	mg/kg	0.83	0.90	8	20	
Copper	mg/kg	79.5	81.8	3	20	
Lead	mg/kg	29.8	32.0	7	20	
Zinc	mg/kg	184	188	2	20	

Results presented on this page are in the units indicated by the "Units" column except where an alternate unit is presented to the right of the result.

REPORT OF LABORATORY ANALYSIS

This report shall not be reproduced, except in full,
without the written consent of Pace Analytical Services, LLC.

QUALITY CONTROL DATA

Project: BPSOU Park Sampling

Pace Project No.: 10618818

QC Batch: 832300

Analysis Method: ASTM D2974

QC Batch Method: ASTM D2974

Analysis Description: Dry Weight / %M by ASTM D2974

Laboratory: Pace Analytical Services - Minneapolis

Associated Lab Samples: 10618818002, 10618818004, 10618818006, 10618818008

SAMPLE DUPLICATE: 4408950

Parameter	Units	10618818002 Result	Dup Result	RPD	Max RPD	Qualifiers
Percent Moisture	%	0.63	0.61	2	30	N2

SAMPLE DUPLICATE: 4408951

Parameter	Units	10618144001 Result	Dup Result	RPD	Max RPD	Qualifiers
Percent Moisture	%	41.9	43.3	3	30	N2

Results presented on this page are in the units indicated by the "Units" column except where an alternate unit is presented to the right of the result.

REPORT OF LABORATORY ANALYSIS

This report shall not be reproduced, except in full,
without the written consent of Pace Analytical Services, LLC.

QUALIFIERS

Project: BPSOU Park Sampling

Pace Project No.: 10618818

DEFINITIONS

DF - Dilution Factor, if reported, represents the factor applied to the reported data due to dilution of the sample aliquot.

ND - Not Detected at or above adjusted reporting limit.

TNTC - Too Numerous To Count

J - Estimated concentration above the adjusted method detection limit and below the adjusted reporting limit.

MDL - Adjusted Method Detection Limit.

PQL - Practical Quantitation Limit.

RL - Reporting Limit - The lowest concentration value that meets project requirements for quantitative data with known precision and bias for a specific analyte in a specific matrix.

S - Surrogate

1,2-Diphenylhydrazine decomposes to and cannot be separated from Azobenzene using Method 8270. The result for each analyte is a combined concentration.

Consistent with EPA guidelines, unrounded data are displayed and have been used to calculate % recovery and RPD values.

LCS(D) - Laboratory Control Sample (Duplicate)

MS(D) - Matrix Spike (Duplicate)

DUP - Sample Duplicate

RPD - Relative Percent Difference

NC - Not Calculable.

SG - Silica Gel - Clean-Up

U - Indicates the compound was analyzed for, but not detected.

N-Nitrosodiphenylamine decomposes and cannot be separated from Diphenylamine using Method 8270. The result reported for each analyte is a combined concentration.

Reported results are not rounded until the final step prior to reporting. Therefore, calculated parameters that are typically reported as "Total" may vary slightly from the sum of the reported component parameters.

Pace Analytical is TNI accredited. Contact your Pace PM for the current list of accredited analytes.

TNI - The NELAC Institute.

ANALYTE QUALIFIERS

N2 The lab does not hold NELAC/TNI accreditation for this parameter but other accreditations/certifications may apply. A complete list of accreditations/certifications is available upon request.

REPORT OF LABORATORY ANALYSIS

This report shall not be reproduced, except in full,
without the written consent of Pace Analytical Services, LLC.

QUALITY CONTROL DATA CROSS REFERENCE TABLE

Project: BPSOU Park Sampling

Pace Project No.: 10618818

Lab ID	Sample ID	QC Batch Method	QC Batch	Analytical Method	Analytical Batch
10618818001	22-RMAP-SNROAD-1	EPA 3050B	832536	EPA 6020A	834148
10618818003	22-RMAP-SNROAD-2	EPA 3050B	832536	EPA 6020A	834148
10618818005	22-RMAP-SNPIT-1	EPA 3050B	832536	EPA 6020A	834148
10618818007	22-RMAP-SNPIT-2	EPA 3050B	832536	EPA 6020A	834148
10618818002	22-RMAP-SNROAD-1	EPA 7471B	832541	EPA 7471B	833446
10618818004	22-RMAP-SNROAD-2	EPA 7471B	832541	EPA 7471B	833446
10618818006	22-RMAP-SNPIT-1	EPA 7471B	832541	EPA 7471B	833446
10618818008	22-RMAP-SNPIT-2	EPA 7471B	832541	EPA 7471B	833446
10618818002	22-RMAP-SNROAD-1	ASTM D2974	832300		
10618818004	22-RMAP-SNROAD-2	ASTM D2974	832300		
10618818006	22-RMAP-SNPIT-1	ASTM D2974	832300		
10618818008	22-RMAP-SNPIT-2	ASTM D2974	832300		

REPORT OF LABORATORY ANALYSIS

This report shall not be reproduced, except in full,
without the written consent of Pace Analytical Services, LLC.



Laboratory Management Program LaMP Chain of Custody Record

STW kg Page 1 of 1
 Req Due Date (mm/dd/yy): Rush TAT: XX No
 Lab Work Order Number:

BP Site Node Path:
 BP Facility No:

Lab Name: Pace Analytical Services
 Lab Address: 1700 Elm Street Minneapolis, MN 55414
 Lab PM: Jennifer Anderson
 Lab Phone: 612-607-1700
 Lab Shipping Acct:
 Lab Bottle Order No:
 Other Info:

Facility Address:
 City, State, ZIP Code:
 Lead Regulatory Agency:
 California Global ID No.:
 Enfos Proposal No:
 Accounting Mode:
 Stage:

Consultant/Contractor: Pioneer Technical Services
 Consultant/Contractor Project No: BPSOU Park Sampling
 Address: 307 E Park Suite 421, Anaconda MT, 59711
 Consultant/Contractor PM: Jesse Schwarrock
 Phone: 406-697-0949 Email: jschwarrock@pioneer-technical.com
 Email EDD To: Jesse Schwarrock
 Invoice To: BP Contractor X

BP Project Manager (PM): Mike McAnulty
 BP PM Phone: 406-723-1822
 BP PM Email: mcanumc@bp.com

Lab No.	Sample Description	Date	Time	Matrix				No. Containers / Preservative				Requested Analyses				Report Type & QC Level	
				Soil / Solid	Water / Liquid	Air / Vapor	Is this location a well?	Total Number of Containers	Unpreserved	H2SO4	HNO3	HCl	Methanol	Air dry&sieve*, 6020 (As, Cd, Cu, Pb, Zn)	7471 Mercury, dry weight		Standard X
22-RMAP-SNROAD-1		07/27/22	8:00 AM	X						2							RUSH TURNAROUND
22-RMAP-SNROAD-2		07/27/22	8:05 AM	X						2							RUSH TURNAROUND
22-RMAP-SNPIT-1		07/27/22	8:15 AM	X						2							RUSH TURNAROUND
22-RMAP-SNPIT-2		07/27/22	8:20	X						2							RUSH TURNAROUND

WO#: 10618818

10618818

Sampler's Name: Cole Dallaserra
 Sampler's Company: Pioneer Technical Services
 Shipment Method: FedEx Overnight Ship Date: 7/27/2022
 Shipment Tracking No: 5405 1821 0385

Relinquished By / Affiliation: *Cole Dallaserra / PTS*
 Date: 7/27/22 Time: 6:00
 Accepted By / Affiliation: *MMBSE/PACE*
 Date: 7/28/22 Time: 8:50

Temp Blank: Yes No
 Cooler Temp on Receipt: 0.4 °F/C
 Trip Blank: Yes No
 MS/MSD Sample Submitted: Yes No

Special Instructions:



DC#_ Title: ENV-FRM-MIN4-0149 v03_Sample Condition Upon Receipt (SCUR) - ESI

Effective Date: 04/12/2022

WO#: 10618818

PM: JMA

Due Date: 08/04/22

CLIENT: BP-PIONEER

Project #:

Sample Condition Upon Receipt - ESI Tech Specs

Client Name:

BP-Pioneer

Courier:

Fed Ex UPS USPS Client Pace Speedee Commercial

Tracking Number:

540518210385

See Exceptions ENV-FRM-MIN4-0142

Custody Seal on Cooler/Box Present? Yes No

Seals Intact? Yes No

Biological Tissue Frozen? Yes No N/A

Packing Material: Bubble Wrap Bubble Bags None Other:

Temp Blank? Yes No

Thermometer: T1(0461) T2(1336) T3(0459) T4(0254) T5(0489) T6(0235) T7(0042)

Type of Ice: Wet Blue None Dry Melted

Temp should be above freezing to 6°C Cooler Temp Read w/temp blank: 0.4 °C

Average Corrected Temp (no temp blank only): See Exceptions ENV-FRM-MIN4-0142 1 Container

Correction Factor: The Cooler Temp Corrected w/temp blank: 0.4 °C

USDA Regulated Soil: N/A, water sample/Other:

Did samples originate in a quarantine zone within the United States: AL, AR, CA, FL, GA, ID, LA, MS, NC, NM, NY, OK, OR, SC, TN, TX or VA (check maps)? Yes No

Date/Initials of Person Examining Contents: PMM 7/28/22

Did samples originate from a foreign source (internationally, including Hawaii and Puerto Rico)? Yes No

If Yes to either question, fill out a Regulated Soil Checklist (ENV-FRM-MIN4-0154) and include with SCUR/COC paperwork.

Table with 2 columns: Questions and Comments. Rows include Chain of Custody Present and Filled Out?, Chain of Custody Relinquished?, Sampler Name and/or Signature on COC?, Samples Arrived within Hold Time?, Short Hold Time Analysis (<72 hr)?, Rush Turn Around Time Requested?, Sufficient Sample Volume?, Triple Volume Provided for MS/MSD (if more than 10 samples)?, Correct Containers Used?, -Pace Containers Used?, Containers Intact?, Field Filtered Volume Received for Dissolved Tests?, Is sufficient information available to reconcile the samples to the COC?, Matrix: Water Soil Oil Other, All containers needing acid/base preservation have been checked?, All containers needing preservation are found to be in compliance with EPA recommendation?, Exceptions: VOA, Coliform, TOC/DOC Oil and Grease, DRO/8015 (water) and Dioxin/PFAS *If adding preservative to a container it must be added to associated field and equipment blanks (verify with PM first), Extra labels present on soil VOA or WIDRO containers?, Headspace in VOA Vials (greater than 6mm)?, 3 Trip Blanks Present?, Trip Blank Custody Seals Present?.

Temp Log: Temp must be maintained at <6°C during login, record temp every 20 mins. Opened Time: 10:15 Temp: 0.4 Corrected Temp: 0.4. Time: 10:35 put in cooler. Time: Temp: Corrected Temp:

CLIENT NOTIFICATION/RESOLUTION Field Data Required? Yes No. Person Contacted: Date/Time: Comments/Resolution:

Project Manager Review:

Date: 08/01/2022

Note: Whenever there is a discrepancy among No. of COC or sample compliance samples, a copy of this form will be sent to the North Carolina DEHNR Certification Office (i.e., out of hold, incorrect preservative, out of temp, incorrect containers)

Labeled by:

PMM (handwritten signature)

Internal Transfer Chain of Custody

4224895



Samples Pre-Logged into eCOC.

State Of Origin: MT

Cert. Needed: Yes No

Owner Received Date: 7/28/2022 Results Requested By: 8/4/2022

Workorder: 10618818 Workorder Name: BPSOU Park Sampling

Report To: Subcontract To: Requested Analysis:

Jennifer Anderson
Pace Analytical Minnesota
1700 Elm Street
Minneapolis, MN 55414
Phone (612)607-6436

Pace Analytical Green Bay
1241 Bellevue Street
Suite 9
Green Bay, WI 54302
Phone (920)469-2436

PB

Preserved Containers

Item	Sample ID	Sample Type	Collect Date/Time	Lab ID	Matrix	Preserved Containers		LAB USE ONLY
						Other		
1	22-RMAP-SNROAD-1	PS	7/27/2022 08:00	10618818001	Solid	1		001
2	22-RMAP-SNROAD-2	PS	7/27/2022 08:05	10618818003	Solid	1		002
3	22-RMAP-SNPIT-1	PS	7/27/2022 08:15	10618818005	Solid	1		003
4	22-RMAP-SNPIT-2	PS	7/27/2022 08:20	10618818007	Solid	1		004
5								

Air Dry & Sieve

Transfers	Released By	Date/Time	Received By	Date/Time	IR40-Rush	Normal processing	Comments
1	Fedex	7/29/22 10:15	Morgan D. O'Leary	7/29/22 10:15			
2					#60 Sieve		
3					Include soil prep log Follow QAPP		

Cooler Temperature on Receipt NA °C Custody Seal or Received on Ice Y or N Samples Intact or N

***In order to maintain client confidentiality, location/name of the sampling site, sampler's name and signature may not be provided on this COC document.
This chain of custody is considered complete as is since this information is available in the owner laboratory.



Laboratory Management Program LaMP Chain of Custody Record

SAW metals Page 1 of 1

Req Due Date (mm/dd/yy): Rush TAT: XX No

Lab Work Order Number:

Lab Name: Pace Analytical Services; Lab Address: 1700 Elm Street Minneapolis, MN 55414; Lab PM: Jennifer Anderson; Lab Phone: 612-607-1700; Lab Shipping Acct: Entos Proposal No.; Lab Bottle Order No.; Other Info: Stage: Activity: Provision

Consultant/Contractor: Pioneer Technical Services; Consultant/Contractor Project No: BPSOU Park Sampling; Address: 307 E Park Suite 421, Anaconda MT, 59711; Consultant/Contractor PM: Jesse Schwarzrock; Phone: 406-697-0949; Email: jschwarzrock@pioneer-technical.com; Invoice To: BP Contractor: X

Table with columns: Lab No., Sample Description, Date, Time, Matrix, No. Containers / Preservative, Requested Analyses, Report Type & QC Level, Relinquished By / Affiliation, Date, Time, Accepted By / Affiliation, Date, Time. Includes rows for samples 001-004 and shipping details.

Special Instructions: THIS LINE - LAB USE ONLY: Custody Seals in Place: 06 / No; Trip Blank: Yes / NO; Cooler Temp on Receipt: NA °F/C; MS/MSD Sample Submitted: Yes / NO

Sample Condition Upon Receipt Form (SCUR)

Client Name: Pace MN

Project #: _____

WO#: **40248955**

Courier: CS Logistics Fed Ex Speedee UPS Walto
 Client Pace Other: _____



Tracking #: 515016029976/51501602998

Custody Seal on Cooler/Box Present: yes no Seals intact: yes no

Custody Seal on Samples Present: yes no Seals intact: yes no

Packing Material: Bubble Wrap Bubble Bags None Other

Thermometer Used SR - 107 Type of Ice: Wet Blue Dry None

Samples on ice, cooling process has begun

Cooler Temperature Uncorr: N/A /Corr: N/A

Temp Blank Present: yes no

Biological Tissue is Frozen: yes no

Person examining contents:

Date: 7/29/22 Initials: MP

Temp should be above freezing to 6°C.
 Biota Samples may be received at ≤ 0°C if shipped on Dry Ice.

Labeled By Initials: _____

Chain of Custody Present:	<input checked="" type="checkbox"/> Yes <input type="checkbox"/> No <input type="checkbox"/> N/A	1.
Chain of Custody Filled Out:	<input checked="" type="checkbox"/> Yes <input type="checkbox"/> No <input type="checkbox"/> N/A	2.
Chain of Custody Relinquished:	<input checked="" type="checkbox"/> Yes <input type="checkbox"/> No <input type="checkbox"/> N/A	3.
Sampler Name & Signature on COC:	<input type="checkbox"/> Yes <input type="checkbox"/> No <input checked="" type="checkbox"/> N/A	4. <u>IRWO 7/29/22 MP</u>
Samples Arrived within Hold Time:	<input checked="" type="checkbox"/> Yes <input type="checkbox"/> No	5.
- VOA Samples frozen upon receipt	<input type="checkbox"/> Yes <input type="checkbox"/> No	Date/Time: _____
Short Hold Time Analysis (<72hr):	<input type="checkbox"/> Yes <input checked="" type="checkbox"/> No	6.
Rush Turn Around Time Requested:	<input checked="" type="checkbox"/> Yes <input type="checkbox"/> No <u>7/29/22 MP</u>	
Sufficient Volume:		8.
For Analysis: <input checked="" type="checkbox"/> Yes <input type="checkbox"/> No MS/MSD: <input type="checkbox"/> Yes <input checked="" type="checkbox"/> No <input type="checkbox"/> N/A		
Correct Containers Used:	<input checked="" type="checkbox"/> Yes <input type="checkbox"/> No	9.
-Pace Containers Used:	<input type="checkbox"/> Yes <input checked="" type="checkbox"/> No <input type="checkbox"/> N/A	
-Pace IR Containers Used:	<input type="checkbox"/> Yes <input type="checkbox"/> No <input checked="" type="checkbox"/> N/A	
Containers Intact:	<input checked="" type="checkbox"/> Yes <input type="checkbox"/> No	10.
Filtered volume received for Dissolved tests	<input type="checkbox"/> Yes <input type="checkbox"/> No <input checked="" type="checkbox"/> N/A	11.
Sample Labels match COC:	<input checked="" type="checkbox"/> Yes <input type="checkbox"/> No <input type="checkbox"/> N/A	12.
-Includes date/time/ID/Analysis Matrix: <u>5</u>		
Trip Blank Present:	<input type="checkbox"/> Yes <input type="checkbox"/> No <input checked="" type="checkbox"/> N/A	13.
Trip Blank Custody Seals Present	<input type="checkbox"/> Yes <input type="checkbox"/> No <input checked="" type="checkbox"/> N/A	
Pace Trip Blank Lot # (if purchased):		

Client Notification/ Resolution:

If checked, see attached form for additional comments

Person Contacted: _____ Date/Time: _____

Comments/ Resolution: _____

PM Review is documented electronically in LIMs. By releasing the project, the PM acknowledges they have reviewed the sample login

Internal Transfer Chain of Custody

4224895



Samples Pre-Logged into eCOC.

State Of Origin: MT
 Cert. Needed: Yes No

Workorder: 10618818 Workorder Name: BPSOU Park Sampling Owner Received Date: 7/28/2022 Results Requested By: 8/4/2022

Report To: Jennifer Anderson
 Pace Analytical Minnesota
 1700 Elm Street
 Minneapolis, MN 55414
 Phone (612)607-6436

Subcontract To: Pace Analytical Green Bay
 1241 Bellevue Street
 Suite 9
 Green Bay, WI 54302
 Phone (920)469-2436

Requester: **WO# : 10618818**

Item	Sample ID	Sample Type	Collect Date/Time	Lab ID	Matrix	Preserved Containers		LAB USE ONLY
						Other		
1	22-RMAP-SNROAD-1	PS	7/27/2022 08:00	10618818001	Solid	1	X	001
2	22-RMAP-SNROAD-2	PS	7/27/2022 08:05	10618818003	Solid	1	X	002
3	22-RMAP-SNPIT-1	PS	7/27/2022 08:15	10618818005	Solid	1	X	003
4	22-RMAP-SNPIT-2	PS	7/27/2022 08:20	10618818007	Solid	1	X	004
5								

Transfers	Released By	Date/Time	Received By	Date/Time	IR40-Rush	Normal processing	Comments
1	Febex	7/29/22 16:15	Morgan [Signature]	7/29/22 10:15			
2	[Signature]	8/1/22 16:00	Ally [Signature]	8/13/22 08:15	#60 Sieve		Include soil prep log
3							Follow QAPP

Cooler Temperature on Receipt - °C Custody Seal or Received on Ice Y or Samples Intact or N

***In order to maintain client confidentiality, location/name of the sampling site, sampler's name and signature may not be provided on this COC document. This chain of custody is considered complete as is since this information is available in the owner laboratory.



DC#_Title: ENV-FRM-MIN4-0150 v05_Sample Condition Upon Receipt (SCUR)

Effective Date: 04/12/2022

Sample Condition Upon Receipt

Client Name: Pace - Green Bay

Project #:

WO#: 10618818
PM: JMA Due Date: 08/04/22
CLIENT: BP-PIONEER

Courier: Fed Ex, UPS, USPS, Pace, SpeeDee, Commercial, Client

Tracking Number: See Exceptions ENV-FRM-MIN4-0142

Custody Seal on Cooler/Box Present? Yes No
Seals Intact? Yes No
Biological Tissue Frozen? Yes No N/A
Packing Material: Bubble Wrap, Bubble Bags, None, Other
Temp Blank? Yes No
Thermometer: T1(0461), T2(1336), T3(0459), T4(0254), T5(0489), T6(0235), T7(0042), 01339252/1710, 122639816, 140792808
Type of Ice: Wet, Blue, None, Dry, Melted

Did Samples Originate in West Virginia? Yes No
Were All Container Temps Taken? Yes No N/A
Temp should be above freezing to 6°C
Cooler Temp Read w/temp blank: AMB °C
Correction Factor: Cooler Temp Corrected w/temp blank: AMB °C
Average Corrected Temp (no temp blank only): °C
See Exceptions ENV-FRM-MIN4-0142
1 Container

USDA Regulated Soil: (N/A, water sample/Other:)
Date/Initials of Person Examining Contents: 08/13/22
Did samples originate in a quarantine zone within the United States: AL, AR, CA, FL, GA, ID, LA, MS, NC, NM, NY, OK, OR, SC, TN, TX or VA (check maps)? Yes No
Did samples originate from a foreign source (internationally, including Hawaii and Puerto Rico)? Yes No
If Yes to either question, fill out a Regulated Soil Checklist ENV-FRM-MIN4-0154 and include with SCUR/COC paperwork.

Table with 2 columns: Location (check one) and COMMENTS. Rows include Chain of Custody Present and Filled Out?, Chain of Custody Relinquished?, Sampler Name and/or Signature on COC?, Samples Arrived within Hold Time?, Short Hold Time Analysis (<72 hr)?, Rush Turn Around Time Requested?, Sufficient Volume?, Correct Containers Used?, Field Filtered Volume Received for Dissolved Tests?, Is sufficient information available to reconcile the samples to the COC?, All containers needing acid/base preservation have been checked?, Exceptions: VOA, Coliform, TOC/DOC Oil and Grease, DRO/8015 (water) and Dioxin/PFAS, Headspace in Methyl Mercury Container?, Extra labels present on soil VOA or WIDRO containers?, Headspace in VOA Vials (greater than 6mm)?, Trip Blank Present?, Trip Blank Custody Seals Present?

CLIENT NOTIFICATION/RESOLUTION

Person Contacted: Date/Time: Field Data Required? Yes No
Comments/Resolution:

Project Manager Review:

[Signature]

Date: 08/16/2022

Note: Whenever there is a discrepancy affecting North Carolina DEHNR Certification Office (i.e., out of hold, incorrect preservative, out of temp, incorrect containers), a copy of this form will be sent to the North Carolina DEHNR Certification Office (i.e., out of hold, incorrect preservative, out of temp, incorrect containers).

Labeled by: [Signature]